

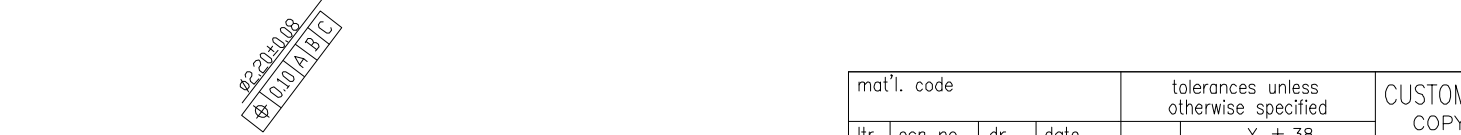

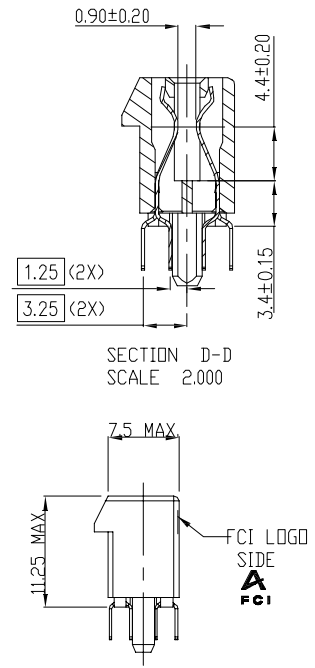

PROD NO
SEE NOTE

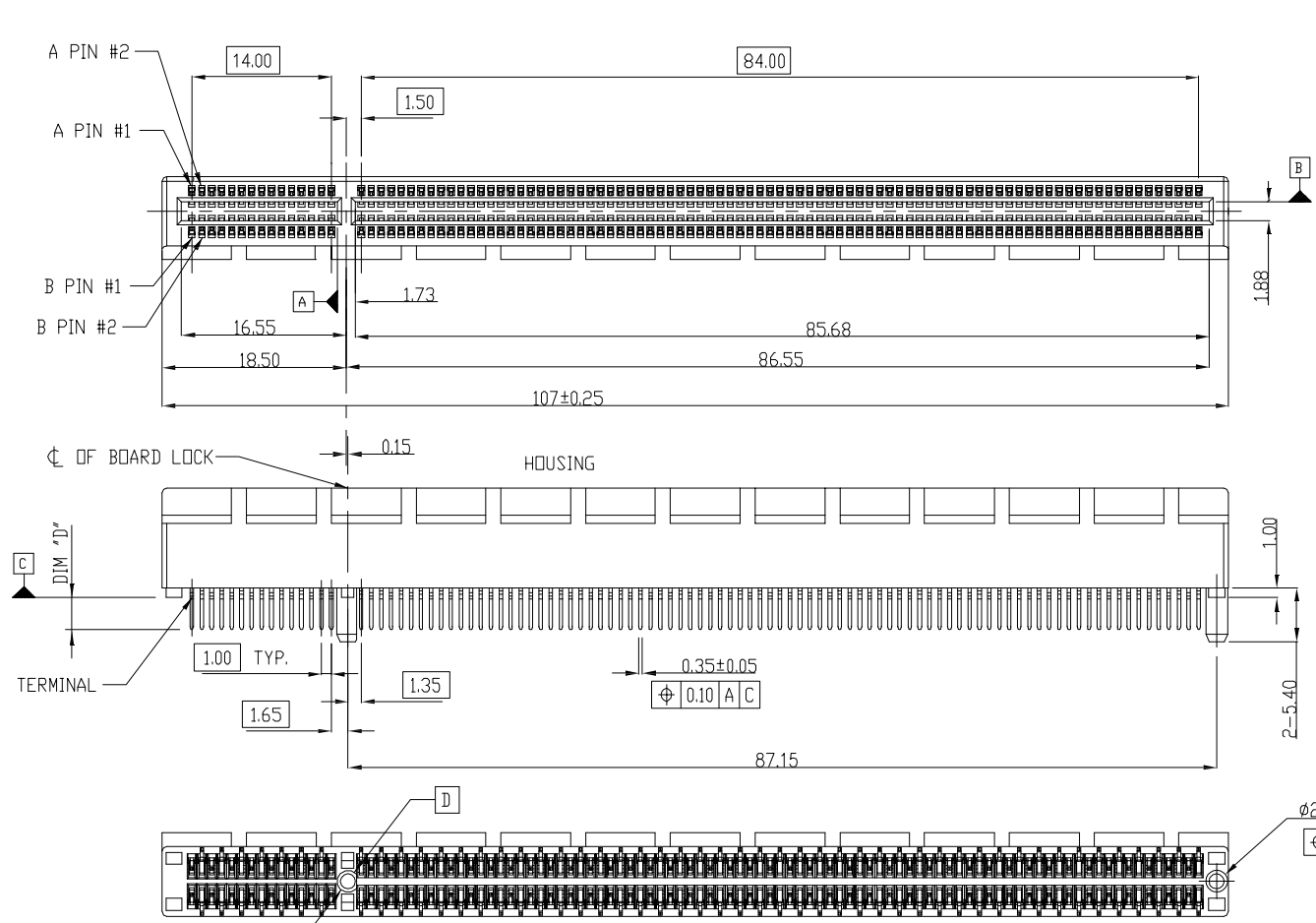

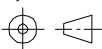

mat'l. code				tolerances unless otherwise specified				CUSTOMER COPY		 www.fciconnect.com	
ltr	ecn no	dr	date	linear	.X ±.38		projection		title		
A	T06-0079	J.H	4/14/06		.XX ±.25				PCI-E 200P CARD EDGE GEN3		
B	ELX-DG-2161-1	S T	05/27/15		.XXX ±.10				code		
				angles	0° ±2°		 MM scale N/A	product family		 sheet 1 of 4	
				dr	STONE LI	05/27/15		PCI			
				enr	STONE LI	05/27/15		size			
				chr	/	/		A4			10054652
				appd	PM ZHENG	05/27/15					
sheet index	revision sheet	B 1	B 2	B 3	B 4						

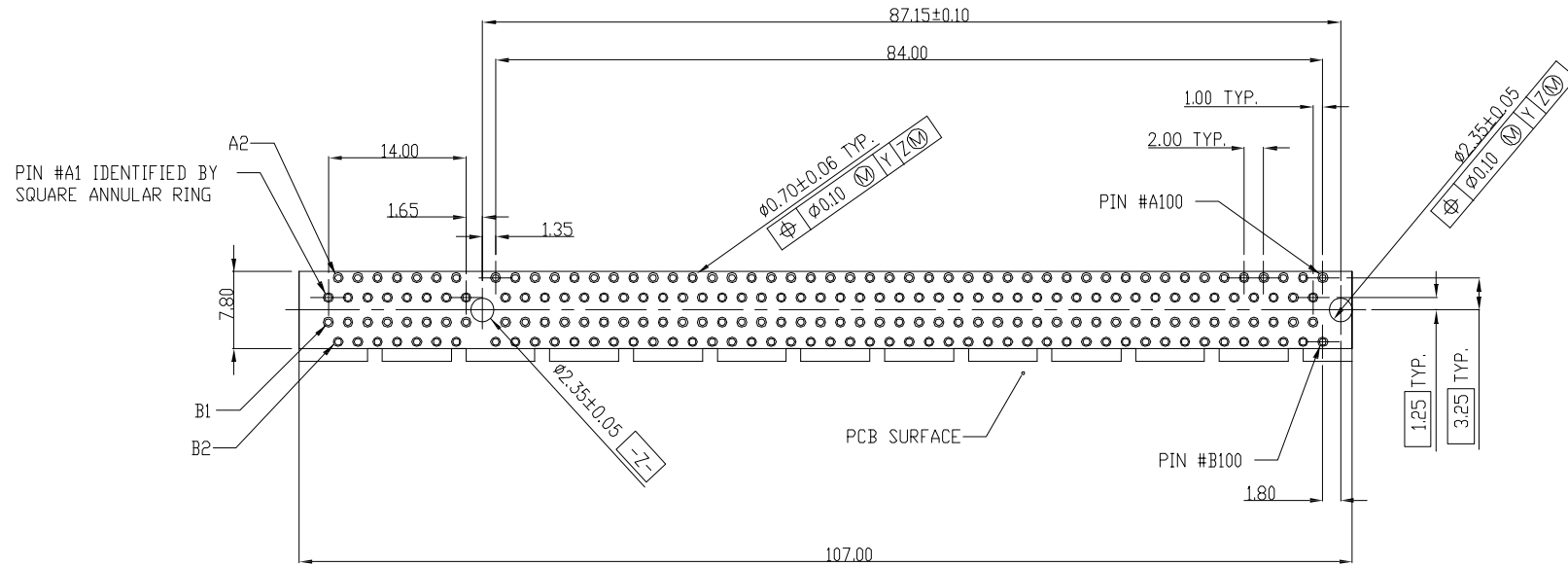
cage code
22526



MOTHER BOARD FOOTPRINT PATTERN
CONNECTOR SIDE SHOWN

mat'l. code				tolerances unless otherwise specified			CUSTOMER COPY		 www.fciconnect.com	
ltr	ecr no	dr	date	linear	.X ±.38		projection	title		
					.XX ±.25			PCI-E 200P CARD EDGE GEN3		
					.XXX ±.10					
				angles	0° ±2°		 MM	product family		code
				dr	STONE LI	05/27/15		PCI		
				enr	STONE LI	05/27/15		size		dwg no
				chr	/	/		A4		10054652
				appd	PM ZHENG	05/27/15		scale		N/A
sheet index		revision sheet								

cage code
22526

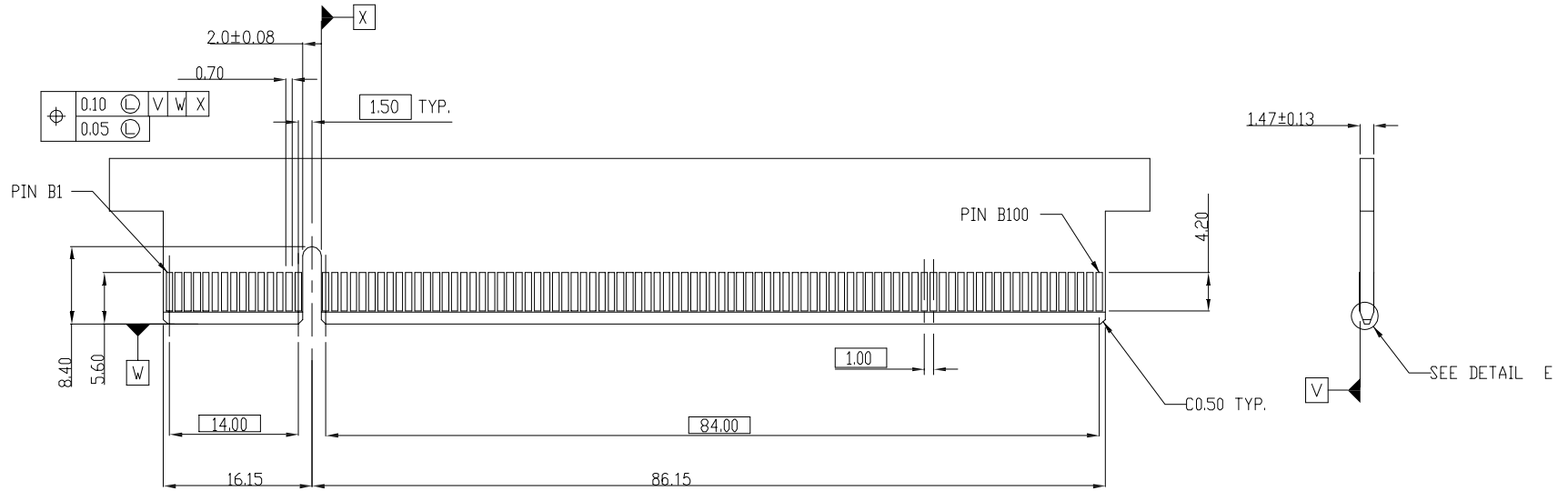

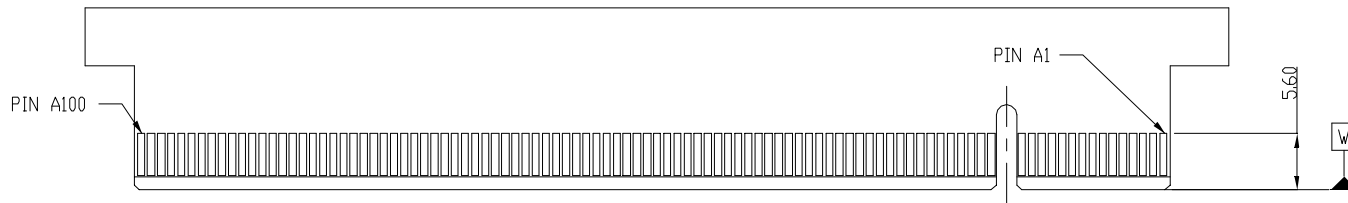

← I/O PANEL DIRECTION
PRIMARY (COMPONENT) SIDE

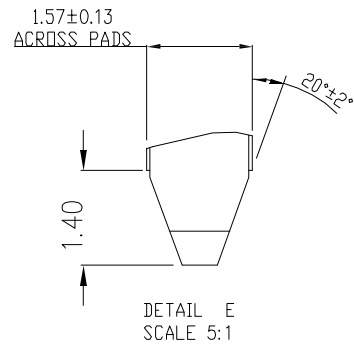

→ I/O PANEL DIRECTION
SECONDARY (SOLDER) SIDE



mat'l. code				tolerances unless otherwise specified			CUSTOMER COPY		 www.fciconnect.com	
ltr	ecn no	dr	date	linear	.X ±.38		projection	title		
					.XX ±.25			PCI-E 200P CARD EDGE GEN3		
				angles	.XXX ±.10			product family		code
					0° ±2'			PCI		-
		dr	STONE LI	05/27/15			MM	size		sheet
		engr	STONE LI	05/27/15				A4		3 of 4
		chr	/	/			N/A	10054652		
		appd	PM ZHENG	05/27/15						
sheet index	revision sheet							cage code		
								22526		

NOTES:

1.MATERIAL:

HOUSING: THERMOPLASTIC WITH GLASS FIBER, UL94V-0, COLOR IN BLACK.
CONTACTS: COPPER ALLOY.

2.FINISH:

CONTACTS: GOLD PLATING ON CONTACT AREA, 100 u"MIN. TIN/LEAD OR MATTE TIN (LEAD FREE OPTION) PLATING ON SOLDER TAILS, 50u"MIN. NICKEL UNDERPLATING OVER ALL.
BOARDLOCKS: 100 u" TIN/LEAD OR MATTE TIN (LEAD FREE OPTION) PLATING ON SOLDER TAILS, 50u"MIN. NICKEL UNDERPLATING OVER ALL.

3. DURABILITY: 50 CYCLES.

4. RoHS COMPATIBLE PRODUCT SPECIFICATIONS

- a. PLATING: "LF" MEANS THE PRODUCT IS LEAD FREE, 2.5um min. MATTE PURE TIN OVER 1.27um MIN. NICKEL UNDERPLATE.
- b. MANUFACTURING PROCESS COMPATIBILITY: THE HOUSING WILL WITHSTAND EXPOSURE TO 260C±5C° SOLDER BATH TEMPERATURE FOR 5 SECONDS IN A WAVE SOLDER APPLICATION WITH A 1.60MM THICK CIRCUIT BOARD.

PRODUCT NUMBER CODE
10054652 - X X X X X X LF

HOUSING COLOR OPTIONS
1-BLACK

PEGS OPTIONS
0-PLASTIC PEGS

TERMINAL PLATING OPTIONS

- 0-50u" Ni UNDERPLATE
 - 30u" Au CONTACT AREA
 - 100u" TIN TAIL AREA -----COMPATIBLE RoHS
- 1-50u" Ni UNDERPLATE
 - 15u" Au CONTACT AREA
 - 100u" TIN TAIL AREA -----COMPATIBLE RoHS
- 2-50u" Ni UNDERPLATE
 - GOLD FLASH CONTACT AREA
 - 100u" TIN TAIL AREA -----COMPATIBLE RoHS

LEAD FREE

PACKAGING OPTIONS
T-TRAY PACKAGING

RESERVE
0

TAIL LENGTH OPTIONS

	DIM "D"	SUGGESTED PCB THICKNESS
1	3.10	2.36±0.10
2	2.54	1.56±0.10

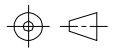
mat'l. code				tolerances unless otherwise specified			CUSTOMER COPY		 www.fciconnect.com	
ltr	ecn no	dr	date	linear	.X ±.38	projection	title PCI-E 200P CARD EDGE GEN3			
					.XX ±.25	 MM	product family		PCI	code
				angles	.XXX ±.10		size	dwg no		-
				dr	0° ±2°	scale	A4		10054652	sheet
				enrg		N/A			4 of 4	
				chr						
				appd						
sheet index	revision sheet									

cage code
22526