



**ON Semiconductor**<sup>®</sup>

<http://onsemi.com>

# LV47011P

Monolithic Linear IC

## 4-Channel BTL Power Amplifier for Car Audio Systems

### Overview

The LV47011P is the IC for 4-channel BTL power amplifier that is developed for car audio system.

Pch DMOS in the upper side of the output stage and Nch DMOS in the lower side of the output stage are complimentary. High power and high quality sound are realized by that.

This IC incorporate various functions (standby switch, muting function, and various protection circuit) necessary for car audio system. Also, it has a self-diagnosis function.

### Functions

- High output :  $P_O$  max = 50W (typical) ( $V_{CC} = 15.2V$ ,  $f = 1kHz$ ,  $R_L = 4\Omega$ , Max power)  
:  $P_O$  max = 29W (typical) ( $V_{CC} = 14.4V$ ,  $f = 1kHz$ , THD = 10%,  $R_L = 4\Omega$ )  
:  $P_O$  max = 22W (typical) ( $V_{CC} = 14.4V$ ,  $f = 1kHz$ , THD = 1%,  $R_L = 4\Omega$ )
- Built-in muting function (pin 22)
- Built-in Standby switch (pin 4)
- Built-in Self-diagnosis function (pin 25) :  
Signal output in case of output offset detection, shorting to  $V_{CC}$ , shorting to ground, and load shorting.
- Electric mirror noise decrease
- Built-in various protection circuit (shorting to ground, shorting to  $V_{CC}$ , load shorting, over voltage and thermal shut down)
- No external anti-oscillation part necessary.

Note 1 : Please do not mistake connection.

A wrong connection may produce destruction, deterioration and damage for the IC or equipment.

Note 2 : The protective circuit function is provided to temporarily avoid abnormal state such as incorrect output connection. But, there is no guarantee that the IC is not destroyed by the accident.

The protective function do not operate of the operation guarantee range. If the outputs are connected incorrectly, IC destruction may occur when used outside of the operation guarantee range.

Note 3 : External parts, such as the anti-oscillation part, may become necessary depending on the set condition. Check their necessity for each set.

# LV47011P

## Specifications

### Maximum Ratings at $T_a = 25^\circ\text{C}$

| Parameter  | Symbol         | Conditions                 | Ratings     | Unit               |
|--|----------------|----------------------------|-------------|--------------------|
| Maximum supply voltage                           | $V_{CC\ max1}$ | No signal, $t = 1$ minute  | 26          | V                  |
|  | $V_{CC\ max2}$ | During operations          | 18          | V                  |
| Maximum output current                           | $I_{O\ peak}$  | Per channel                | 4.5/ch      | A                  |
| Allowable power dissipation                      | $P_d\ max$     | With an infinity heat sink | 50          | W                  |
| Operating temperature                            | $T_{opr}$      |                            | -40 to +85  | $^\circ\text{C}$   |
| Storage temperature                              | $T_{stg}$      |                            | -40 to +150 | $^\circ\text{C}$   |
| Thermal resistance between the junction and case | $\theta_{j-c}$ |                            | 1           | $^\circ\text{C/W}$ |

Stresses exceeding Maximum Ratings may damage the device. Maximum Ratings are stress ratings only. Functional operation above the Recommended Operating Conditions is not implied. Extended exposure to stresses above the Recommended Operating Conditions may affect device reliability.

### Recommended Operating Ranges at $T_a = 25^\circ\text{C}$

| Parameter                      | Symbol       | Conditions                       | Ratings | Unit     |
|--------------------------------|--------------|----------------------------------|---------|----------|
| Recommended supply voltage     | $V_{CC}$     |                                  | 14.4    | V        |
| Recommended load resistance    | $R_L\ op$    |                                  | 4       | $\Omega$ |
| Operating supply voltage range | $V_{CC\ op}$ | A range not exceeding $P_{dmax}$ | 8 to 16 | V        |

### Electrical Characteristics at $T_a = 25^\circ\text{C}$ , $V_{CC} = 14.4\text{V}$ , $R_L = 4\Omega$ , $f = 1\text{kHz}$ , $R_g = 600\Omega$

| Parameter                      | Symbol        | Conditions   | Ratings   |           |           | Unit             |
|--------------------------------|---------------|--|-----------|-----------|-----------|------------------|
|                                |               |  | min       | typ       | max       |                  |
| Quiescent current              | $I_{CCO}$     | $R_L = \infty$ , $R_g = 0\Omega$                                 |           | 200       | 400       | mA               |
| Standby current                | $I_{st}$      | $V_{st} = 0\text{V}$   |           |           | 3         | $\mu\text{A}$    |
| Voltage gain                   | $V_G$         | $V_O = 0\text{dBm}$  | 25        | 26        | 27        | dB               |
| Voltage gain difference        | $\Delta V_G$  |  | -1        |           | +1        | dB               |
| Output power                   | $P_O$         | THD = 10%  | 24        | 29        |           | W                |
|                                | $P_O\ max1$   | Max Power  |           | 45        |           | W                |
|                                | $P_O\ max2$   | $V_{CC} = 15.2$ , Max Power                                      |           | 50        |           | W                |
| Output offset voltage          | $V_n\ offset$ | $R_g = 0\Omega$  | -100      |           | +100      | mV               |
| Total harmonic distortion      | THD           | $P_O = 4\text{W}$  |           | 0.03      | 0.12      | %                |
| Channel separation             | CHsep         | $V_O = 0\text{dBm}$ , $R_g = 10\text{k}\Omega$                   | 55        | 65        |           | dB               |
| Ripple rejection ratio         | SVRR          | $R_g = 0\Omega$ , $f_r = 100\text{Hz}$ , $V_{CCR} = 0\text{dBm}$ | 50        | 65        |           | dB               |
| Output noise voltage           | $V_{NO}$      | $R_g = 0\Omega$ , B.P.F. = 20Hz to 20kHz                         |           | 80        | 150       | $\mu\text{Vrms}$ |
| Input resistance               | $R_i$         |  | 40        | 50        | 65        | $\text{k}\Omega$ |
| Mute attenuation               | Matt          | $V_O = 20\text{dBm}$ , mute : on                                 | 75        | 90        |           | dB               |
| Standby pin control voltage    | $V_{stby\ H}$ | Amp : on   | 2.5       |           | $V_{CC}$  | V                |
|                                | $V_{stby\ L}$ | Amp : off  | 0.0       |           | 0.5       | V                |
| Mute pin control voltage       | $V_{mute\ H}$ | Mute : off   | Open      |           |           | -                |
|                                | $V_{mute\ L}$ | Mute : on  | 0.0       |           | 1.0       | V                |
| <b>Output offset detection</b> |               |  |           |           |           |                  |
| Detection threshold voltage    | $V_{osdet}$   |  | $\pm 1.2$ | $\pm 1.8$ | $\pm 2.4$ | V                |

\* 0dBm = 0.775Vrms

# LV47011P

## Package Dimensions

unit : mm (typ)  
3236A

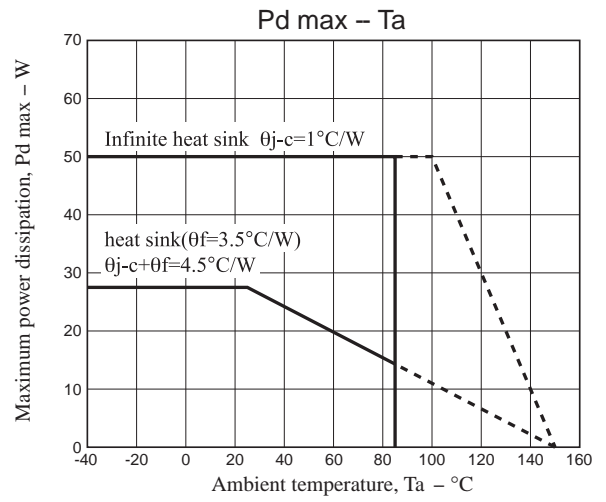
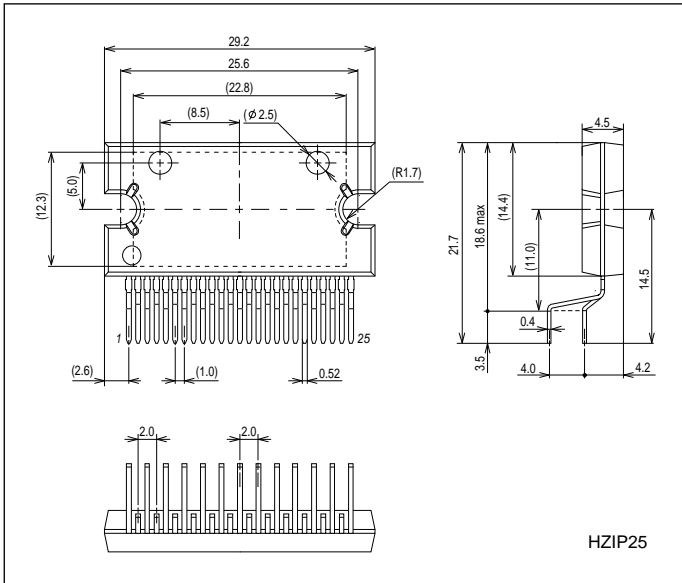

## Block Diagram

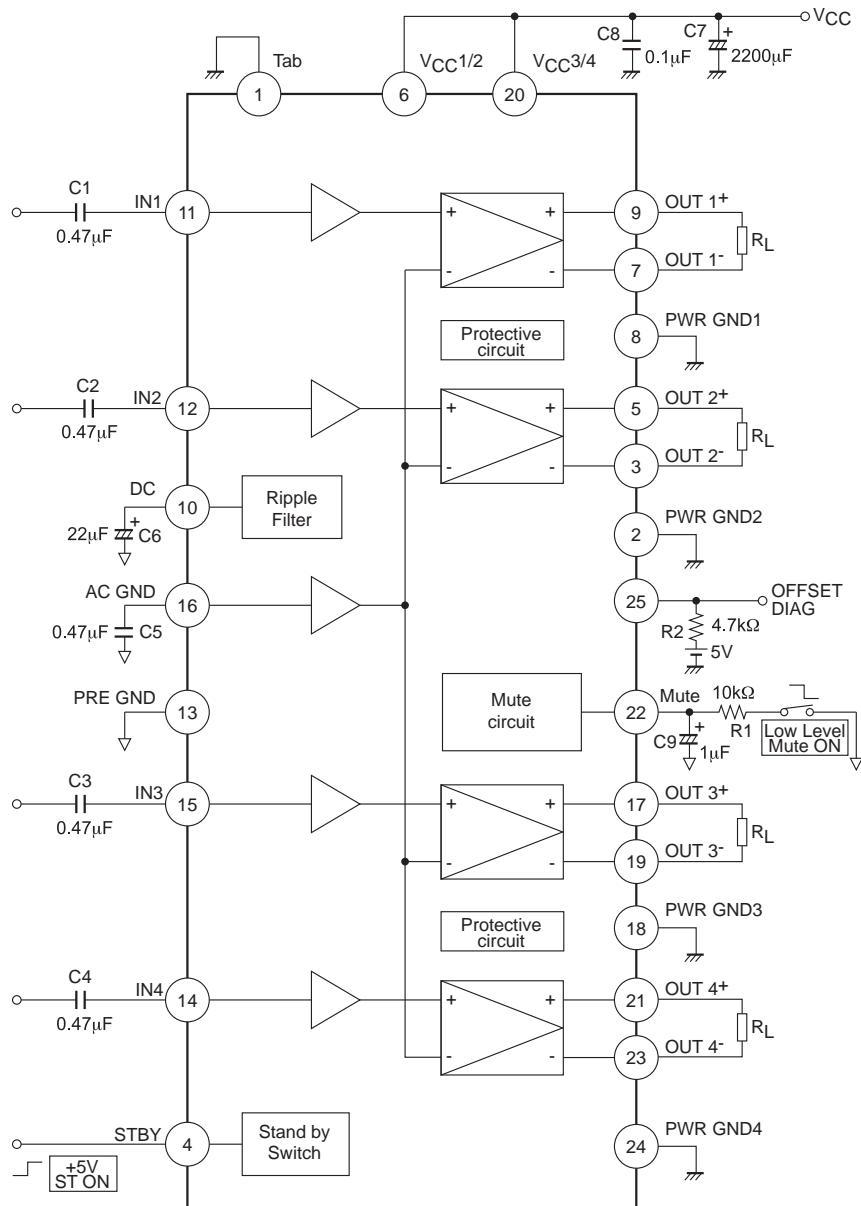

# LV47011P

## External Components

| Part Name | Recommended Value | Purpose                              | Remarks   |
|-----------|-------------------|--------------------------------------|---|
| C1 to C5  | 0.47μF            | Cuts DC voltage                      | The larger the constant value, the lower the cut-off frequency<br>The values of C1 to C5 must be the same |
| C6        | 22μF              | Reduces ripples<br>Reduces pop noise | The larger the constant value, the longer the amplifier ON/OFF time                                       |
| C7        | 2200μF            | Ripple filter                        | Eliminating power supply ripples  |
| C8        | 0.1μF             | Improves oscillation stability       | Reducing high-frequency noise   |
| C9        | 1μF               | Reduces pop noise                    | The larger the constant value, the longer the mute ON/OFF time  |
| R1        | 10kΩ              | Reduces pop noise                    | The larger the constant value, the longer the mute ON/OFF time  |
| R2        | 4.7kΩ             | Pull-up resistor                     |   |

\* The components and constant values within the test circuit are used for confirmation of characteristics and are not guarantees that incorrect or trouble will not occur in application equipment.

## Description of Operation

### 1. Standby switch function (pin 4)

Threshold voltage of the pin 4 is set by about  $2V_{BE}$ .

The amplifier is turned on by the applied voltage of 2.5V or more. Also, the amplifier is turned off by the applied voltage of 0.5V or less.

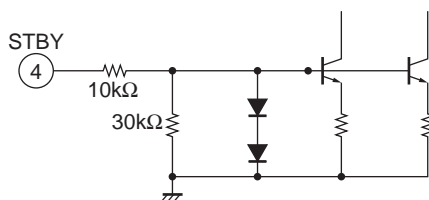

Fig1 Standby equivalent circuit

### 2. Muting function (pin 22)

The muted state is obtained by setting pin 22 to the ground potential, enabling audio muting.

The muting function is turned on by the applied voltage of 1V or less to the resistance of pin 22. And the muting function is turned off when this pin opens.

Also, the time constant of the muting function is determined by external capacitor and resistor constants.

It is concerned with a pop noise in amplifier ON/OFF and mute ON/OFF. After enough examination, please set it.

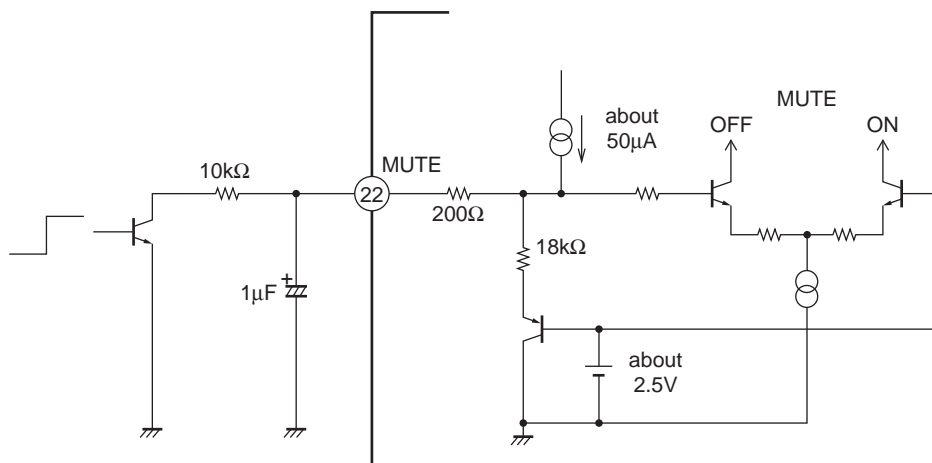

Fig2 Mute equivalent circuit

### 3. ACGND pin (pin 16)

The capacitor of the pin 16 must use the same capacitance value as the input capacitor.

Also, connect to the same PREGND as the input capacitor.

### 4. Self-diagnostics function (pin 25)

By detecting the unusual state of the IC, the signal is output to the pin 25.

Also, by controlling the standby switch after the signal of the pin 25 is detected by the microcomputer, the burnout of the speaker can be prevented.

- (1) Shorting to  $V_{CC}$ /Shorting to ground : The pin 25 becomes the low level.
- (2) Load shorting : The pin 25 is alternated between the low level and the high level according to the output signal.
- (3) Output offset detection : when the output offset voltage exceeds the detection threshold voltage, the pin 25 becomes the low level.

\* Note: The output offset abnormality is thought of as the leakage current of the input capacitor.

In addition, the pin 25 has become the NPN open collector output (active low).

The pin 25 must be left open when this function is not used.

### 5. Sound quality (low frequencies)

By varying the value of input capacitor, low-frequency characteristic can be improved.

However, it is concerned the shock noise. Please confirm in each set when the capacitance value varies.

### 6. Pop noise

For pop noise prevention, it is recommended to use the muting function at the same time.

- Please turn on the muting function simultaneously with power supply on when the amplifier is turned on. Next, turn off the muting function after the output DC potential stabilization.
- When the amplifier is turn off, turn off the power supply after turning on the muting function.

### 7. Oscillation stability

Pay due attention on the following points because parasitic oscillation may occur due to effects of the capacity load, board layout, etc.

#### (1) Capacity load

When the capacitor is to be inserted between each output pin and GND so as to prevent electric mirror noise, select the capacitance of maximum 1500pF. (Conditions : Our recommended board,  $R_L = 4\Omega$ )

#### (2) Board layout

- Provide the  $V_{CC}$  capacitor of 0.1 $\mu$ F in the position nearest to IC.
- PREGND must be independently wired and connected to the GND point that is as stable as possible, such as the minus pin of the 2200 $\mu$ F  $V_{CC}$  capacitor.

In case of occurrence of parasitic oscillation, any one of following parts may be added as a countermeasure.

Note that the optimum capacitance must be checked for each set in the mounted state.

- Series connection of CR (0.1 $\mu$ F and 2.2 $\Omega$ ) between BTL outputs
- Series connection of CR(0.1 $\mu$ F and 2.2 $\Omega$ ) between each output pin and GND.

# LV47011P

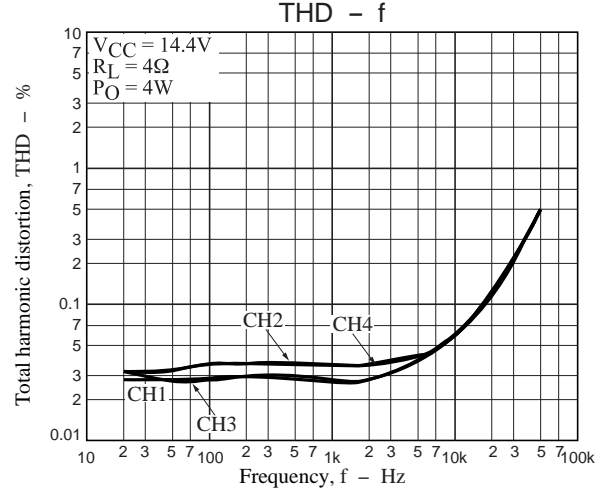
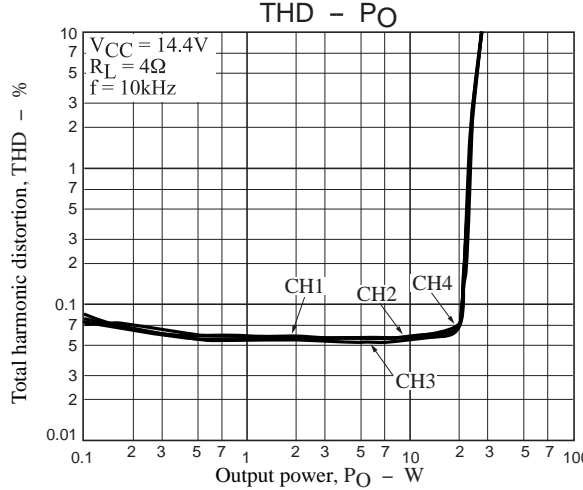
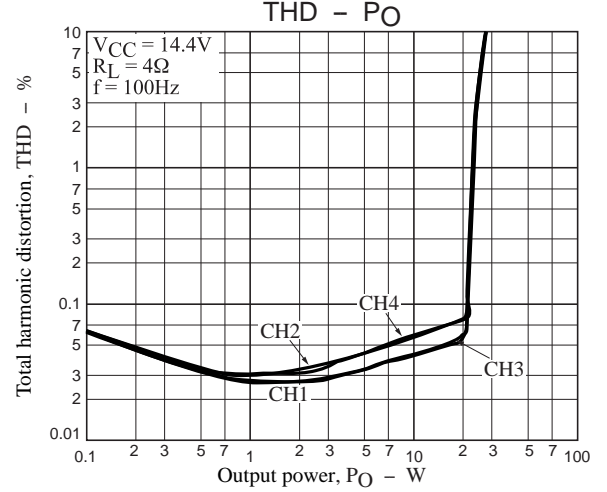
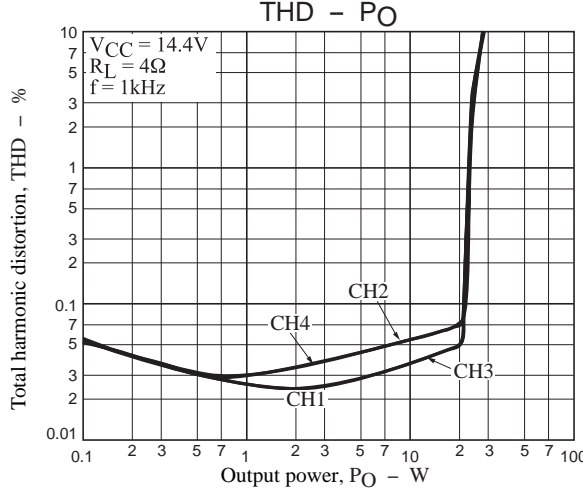
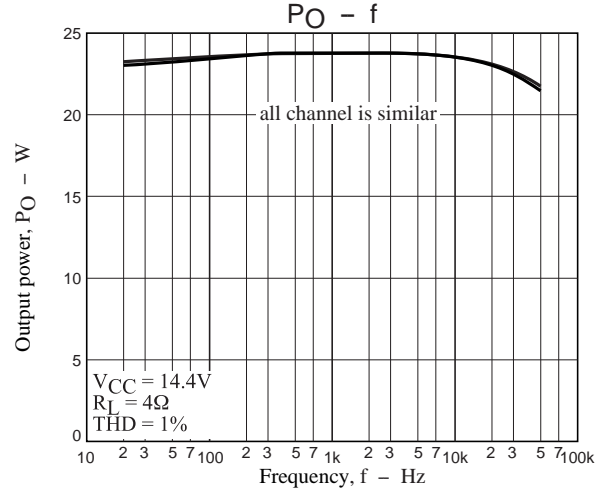
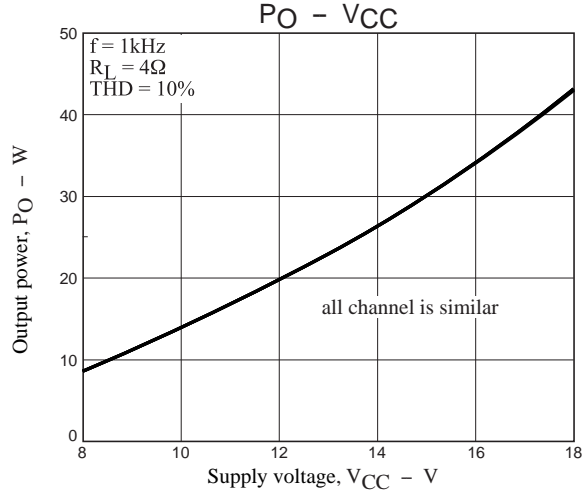
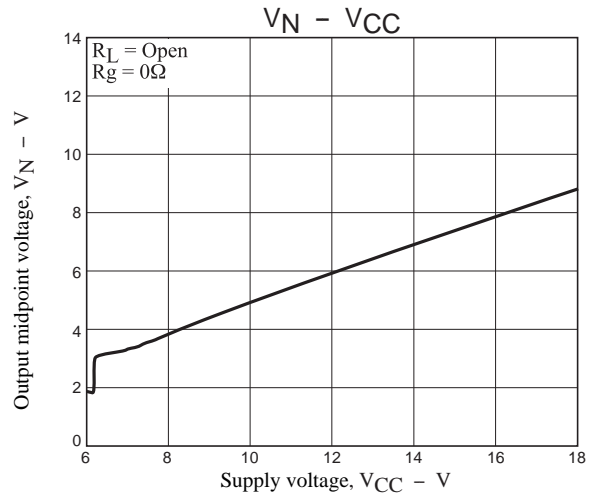
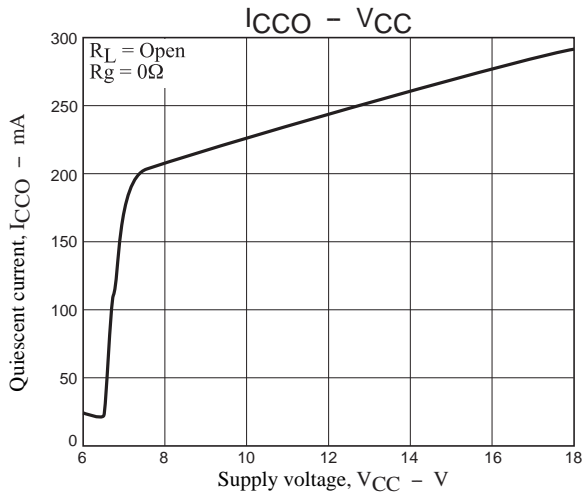

# LV47011P

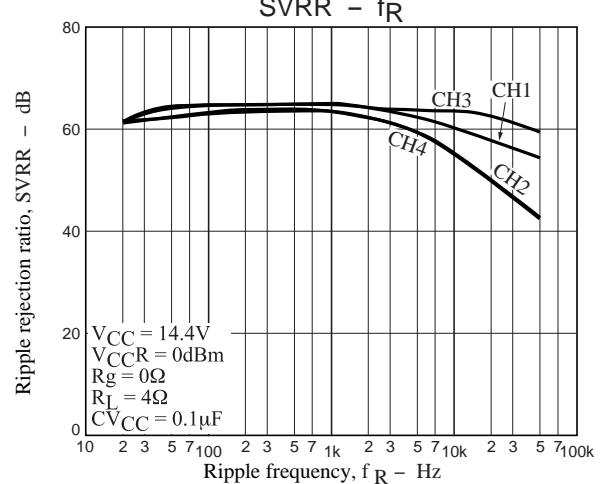
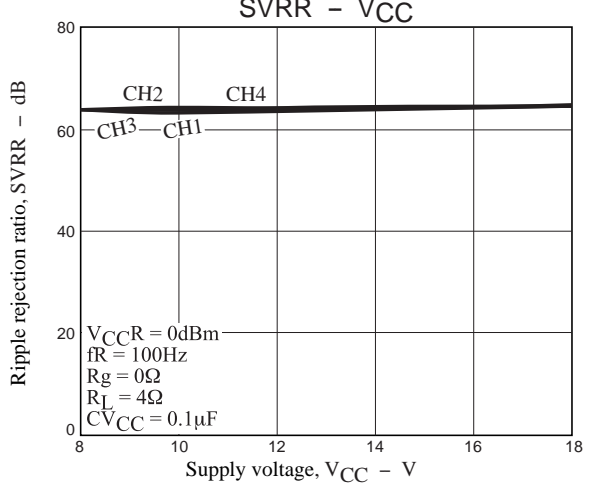
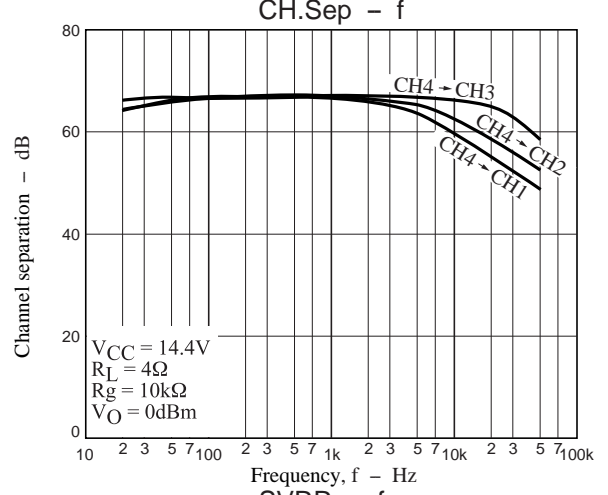
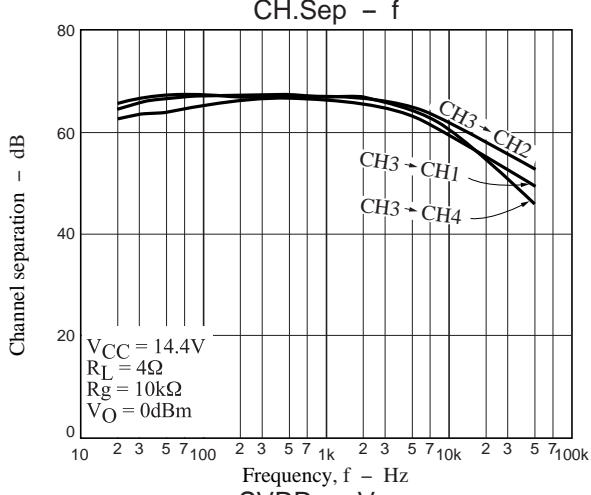
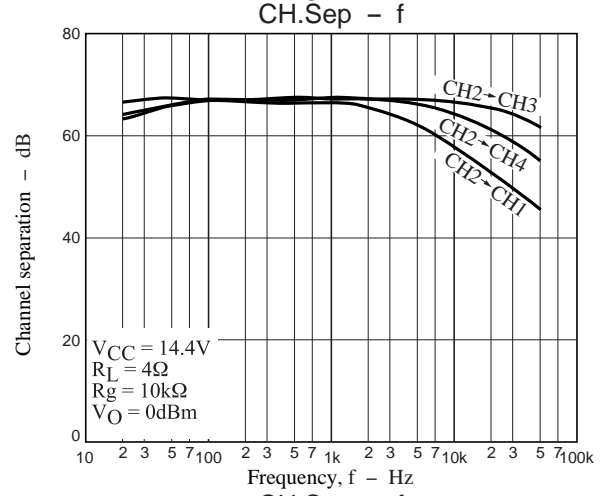
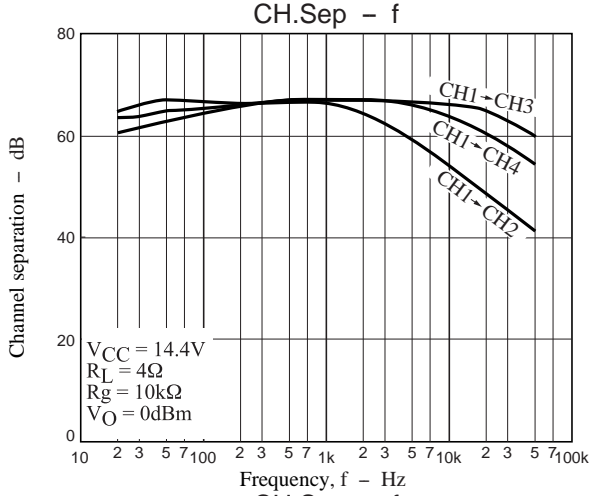
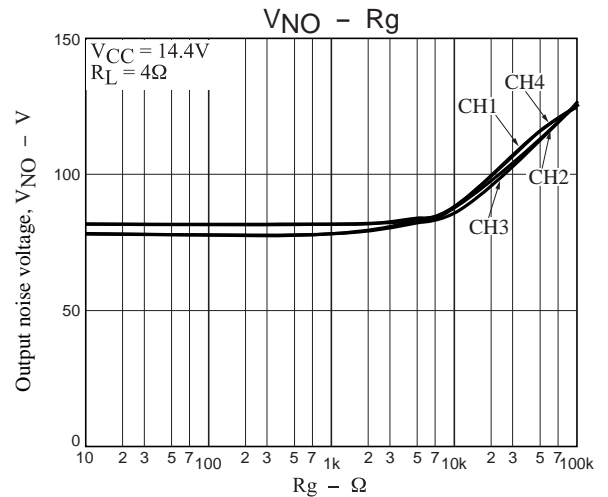
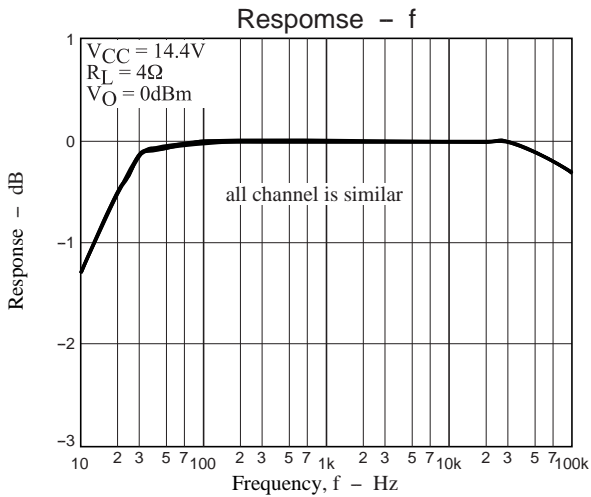

# LV47011P

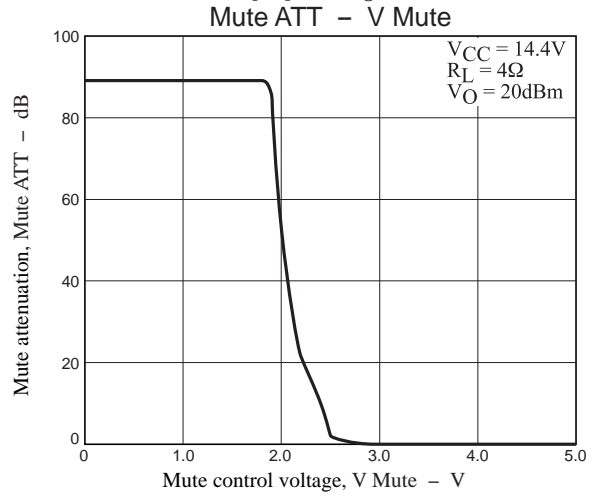
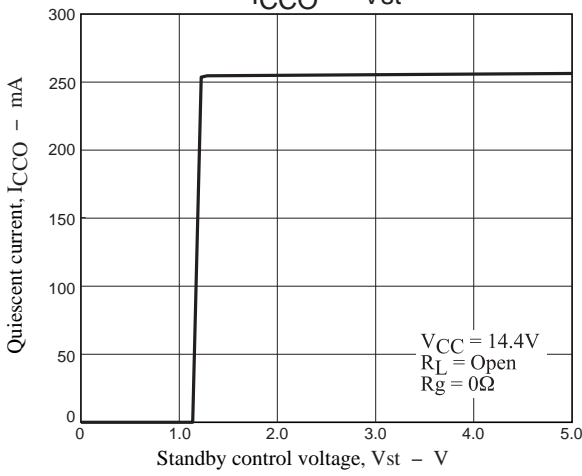
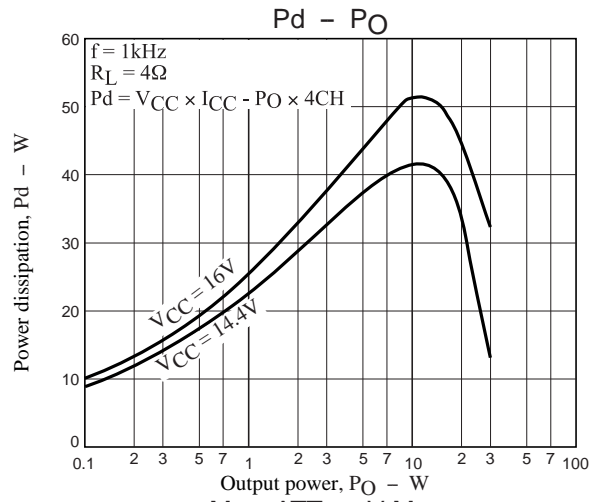
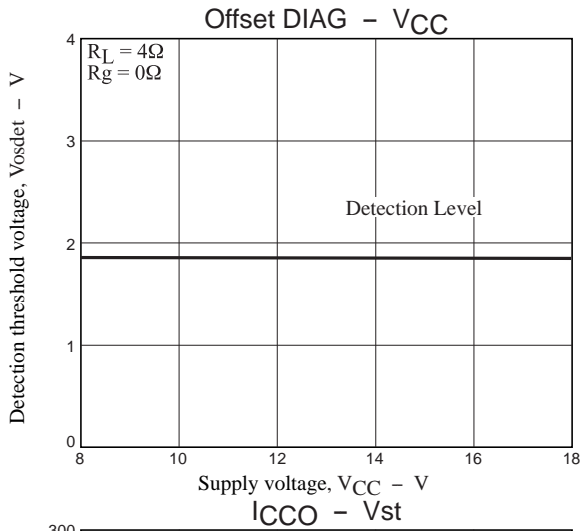



HZIP25 Heat sink attachment

Heat sinks are used to lower the semiconductor device junction temperature by leading the heat generated by the device to the outer environment and dissipating that heat.

- a. Unless otherwise specified, for power ICs with tabs and power ICs with attached heat sinks, solder must not be applied to the heat sink or tabs.

b. Heat sink attachment

- Use flat-head screws to attach heat sinks.
- Use also washer to protect the package.
- Use tightening torques in the ranges 39-59Ncm(4-6kgcm) .
- If tapping screws are used, do not use screws with a diameter larger than the holes in the semiconductor device itself.
- Do not make gap, dust, or other contaminants to get between the semiconductor device and the tab or heat sink.
- Take care a position of via hole .
- Do not allow dirt, dust, or other contaminants to get between the semiconductor device and the tab or heat sink.
- Verify that there are no press burrs or screw-hole burrs on the heat sink.
- Warping in heat sinks and printed circuit boards must be no more than 0.05 mm between screw holes, for either concave or convex warping.
- Twisting must be limited to under 0.05 mm.
- Heat sink and semiconductor device are mounted in parallel.  
Take care of electric or compressed air drivers
- The speed of these torque wrenches should never exceed 700 rpm, and should typically be about 400 rpm.

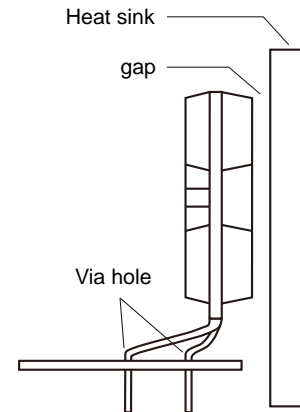
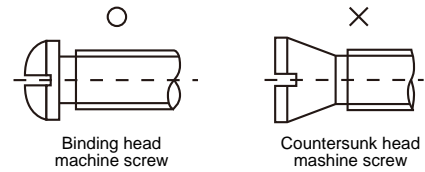

c. Silicone grease

- Spread the silicone grease evenly when mounting heat sinks.
- Our company recommends YG-6260 (Momentive Performance Materials Japan LLC)

d. Mount

- First mount the heat sink on the semiconductor device, and then mount that assembly on the printed circuit board.
- When attaching a heat sink after mounting a semiconductor device into the printed circuit board, when tightening up a heat sink with the screw, the mechanical stress which is impossible to the semiconductor device and the pin doesn't hang.

e. When mounting the semiconductor device to the heat sink using jigs, etc.,

- Take care not to allow the device to ride onto the jig or positioning dowel.
- Design the jig so that no unreasonable mechanical stress is not applied to the semiconductor device.

f. Heat sink screw holes

- Be sure that chamfering and shear drop of heat sinks must not be larger than the diameter of screw head used.
- When using nuts, do not make the heat sink hole diameters larger than the diameter of the head of the screws used. A hole diameter about 15% larger than the diameter of the screw is desirable.
- When tap screws are used, be sure that the diameter of the holes in the heat sink are not too small. A diameter about 15% smaller than the diameter of the screw is desirable.

- g. There is a method to mount the semiconductor device to the heat sink by using a spring band. But this method is not recommended because of possible displacement due to fluctuation of the spring force with time or vibration.

ON Semiconductor and the ON logo are registered trademarks of Semiconductor Components Industries, LLC (SCILLC). SCILLC owns the rights to a number of patents, trademarks, copyrights, trade secrets, and other intellectual property. A listing of SCILLC's product/patent coverage may be accessed at [www.onsemi.com/site/pdf/Patent-Marking.pdf](http://www.onsemi.com/site/pdf/Patent-Marking.pdf). SCILLC reserves the right to make changes without further notice to any products herein. SCILLC makes no warranty, representation or guarantee regarding the suitability of its products for any particular purpose, nor does SCILLC assume any liability arising out of the application or use of any product or circuit, and specifically disclaims any and all liability, including without limitation special, consequential or incidental damages. "Typical" parameters which may be provided in SCILLC data sheets and/or specifications can and do vary in different applications and actual performance may vary over time. All operating parameters, including "Typicals" must be validated for each customer application by customer's technical experts. SCILLC does not convey any license under its patent rights nor the rights of others. SCILLC products are not designed, intended, or authorized for use as components in systems intended for surgical implant into the body, or other applications intended to support or sustain life, or for any other application in which the failure of the SCILLC product could create a situation where personal injury or death may occur. Should Buyer purchase or use SCILLC products for any such unintended or unauthorized application, Buyer shall indemnify and hold SCILLC and its officers, employees, subsidiaries, affiliates, and distributors harmless against all claims, costs, damages, and expenses, and reasonable attorney fees arising out of, directly or indirectly, any claim of personal injury or death associated with such unintended or unauthorized use, even if such claim alleges that SCILLC was negligent regarding the design or manufacture of the part. SCILLC is an Equal Opportunity/Affirmative Action Employer. This literature is subject to all applicable copyright laws and is not for resale in any manner.