

LED Drivers for High Power LEDs

ILD4035

350 mA Step Down LED Driver

Data Sheet

Revision 2.0, 2011-08-17

Industrial and Multimarket

Edition 2011-08-17

**Published by
Infineon Technologies AG
81726 Munich, Germany**

**© 2011 Infineon Technologies AG
All Rights Reserved.**

Legal Disclaimer

The information given in this document shall in no event be regarded as a guarantee of conditions or characteristics. With respect to any examples or hints given herein, any typical values stated herein and/or any information regarding the application of the device, Infineon Technologies hereby disclaims any and all warranties and liabilities of any kind, including without limitation, warranties of non-infringement of intellectual property rights of any third party.

Information

For further information on technology, delivery terms and conditions and prices, please contact the nearest Infineon Technologies Office (www.infineon.com).

Warnings

Due to technical requirements, components may contain dangerous substances. For information on the types in question, please contact the nearest Infineon Technologies Office.

Infineon Technologies components may be used in life-support devices or systems only with the express written approval of Infineon Technologies, if a failure of such components can reasonably be expected to cause the failure of that life-support device or system or to affect the safety or effectiveness of that device or system. Life support devices or systems are intended to be implanted in the human body or to support and/or maintain and sustain and/or protect human life. If they fail, it is reasonable to assume that the health of the user or other persons may be endangered.

Revision History

Page or Item	Subjects (major changes since previous revision)
Revision 2.0, 2011-08-17	
Table 2	Maximum peak current specified for hysteretic peak condition
Table 2	Maximum junction temperature increased to 150 °C
Figure 3	Safe operating area increased
Table 4	Maximum supply voltage reduced to 40 V
Table 4	Overall current consumption and standby current reduced
Table 4	Over temperature protection improved from flicker to sloped behaviour
Table 5	Application setup changed
Table 6	Voltage range of digital control signals changed
Chapter 6.3	Over temperature protection improved from flicker to sloped behaviour
Chapter 6.4	Figures of switching parameters changed
Revision 1.0, 2010-11-11	

Trademarks of Infineon Technologies AG

AURIX™, BlueMoon™, C166™, CanPAK™, CIPOS™, CIPURSE™, COMNEON™, EconoPACK™, CoolMOS™, CoolSET™, CORECONTROL™, CROSSAVE™, DAVE™, EasyPIM™, EconoBRIDGE™, EconoDUAL™, EconoPIM™, EiceDRIVER™, eupec™, FCOS™, HITFET™, HybridPACK™, I²RF™, ISOFACE™, IsoPACK™, MIPAQ™, ModSTACK™, my-d™, NovalithIC™, OmniTune™, OptiMOS™, ORIGA™, PRIMARION™, PrimePACK™, PrimeSTACK™, PRO-SIL™, PROFET™, RASIC™, ReverSave™, SatRIC™, SIEGET™, SINDRION™, SIPMOS™, SMARTi™, SmartLEWIS™, SOLID FLASH™, TEMPFET™, thinQ!™, TRENCHSTOP™, TriCore™, X-GOLD™, X-PMU™, XMM™, XPOSYS™.

Other Trademarks

Advance Design System™ (ADS) of Agilent Technologies, AMBA™, ARM™, MULTI-ICE™, KEIL™, PRIMECELL™, REALVIEW™, THUMB™, µVision™ of ARM Limited, UK. AUTOSAR™ is licensed by AUTOSAR development partnership. Bluetooth™ of Bluetooth SIG Inc. CAT-iq™ of DECT Forum. COLOSSUS™, FirstGPS™ of Trimble Navigation Ltd. EMV™ of EMVCo, LLC (Visa Holdings Inc.). EPCOS™ of Epcos AG. FLEXGO™ of Microsoft Corporation. FlexRay™ is licensed by FlexRay Consortium. HYPERTERMINAL™ of Hilgraeve Incorporated. IEC™ of Commission Electrotechnique Internationale. IrDA™ of Infrared Data Association Corporation. ISO™ of INTERNATIONAL ORGANIZATION FOR STANDARDIZATION. MATLAB™ of MathWorks, Inc. MAXIM™ of Maxim Integrated Products, Inc. MICROTEC™, NUCLEUS™ of Mentor Graphics Corporation. Mifare™ of NXP. MIPI™ of MIPI Alliance, Inc. MIPS™ of MIPS Technologies, Inc., USA. muRata™ of MURATA MANUFACTURING CO., MICROWAVE OFFICE™ (MWO) of Applied Wave Research Inc., OmniVision™ of OmniVision Technologies, Inc. Openwave™ Openwave Systems Inc. RED HAT™ Red Hat, Inc. RFMD™ RF Micro Devices, Inc. SIRIUS™ of Sirius Satellite Radio Inc. SOLARIS™ of Sun Microsystems, Inc. SPANSION™ of Spansion LLC Ltd. Symbian™ of Symbian Software Limited. TAIYO YUDEN™ of Taiyo Yuden Co. TEAKLITE™ of CEVA, Inc. TEKTRONIX™ of Tektronix Inc. TOKO™ of TOKO KABUSHIKI KAISHA TA. UNIX™ of X/Open Company Limited. VERILOG™, PALLADIUM™ of Cadence Design Systems, Inc. VLYNQ™ of Texas Instruments Incorporated. VXWORKS™, WIND RIVER™ of WIND RIVER SYSTEMS, INC. ZETEX™ of Diodes Zetex Limited.

Last Trademarks Update 2010-10-26

Table of Contents

	Table of Contents	4
	List of Figures	5
	List of Tables	6
1	Features	8
2	Product Brief	9
3	Maximum Ratings	11
4	Thermal Characteristics	12
5	Electrical Characteristics	14
5.1	DC Characteristics	14
5.2	Switching Characteristics	15
5.3	Digital Signals	15
6	Basic Application Information	16
6.1	Setting the average LED current	16
6.2	Dimming of the LEDs	16
6.3	Temperature Protection Circuit	19
6.4	Switching Parameters	19
7	Application Circuit	28
8	Evaluation Board	28
9	Package Information	29

List of Figures

Figure 1	Block Diagram	9
Figure 2	Total Power Dissipation	12
Figure 3	Safe Operating Area	13
Figure 4	PWM Dimming	18
Figure 5	Application Circuit	28
Figure 6	ILD4035 on Evaluation Board	28
Figure 7	Package Outline SC74	29
Figure 8	Recommended PCB Footprint for Reflow Soldering	29
Figure 9	Tape Loading	29

List of Tables

Table 1	Pin Definition and Function	10
Table 2	Maximum Ratings	11
Table 3	Maximum Thermal Resistance	12
Table 4	DC Characteristics	14
Table 5	Switching Characteristics	15
Table 6	Digital Control Parameter at Pin EN/PWM	15



350 mA Step Down LED Driver with Internal Switch ILD4035

1 Features

- Wide input voltage range: 4.5 V ... 40 V
- Internal switch for up to 400 mA average LED current
- Up to 95 % efficiency
- Over current protection
- Over voltage protection
- Temperature protection mechanism
- Inherent open-circuit LED protection
- Soft-start capability
- Low shut down current
- Analog and PWM dimming possible
- Typical 3 % output current accuracy
- Minimum external components required
- Small package: SC74

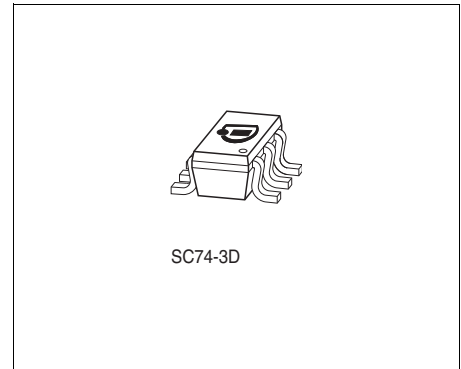

Applications

- LED driver for general lighting applications
- Retail, office and residential luminaires and downlights
- LED replacement lamps
- Architectural lighting

Product Name	Package	Pin Configuration						Marking
ILD4035	SC74-6-4	1 = V_S	2 = GND	3 = EN	4 = V_{switch}	5 = GND	6 = V_{sense}	35

2 Product Brief

The ILD4035 is a hysteretic step down LED driver IC for general lighting applications, which is capable to drive high power LEDs with average currents up to 400 mA.

The IC incorporates a wide input voltage range and an internal power switch. The output current level can be adjusted with an external sense resistor.

According to the multifunctional control pin the IC can be switched on and off by an external signal, which is also suitable to regulate brightness of the LEDs by PWM or analog voltage dimming.

Depending on the value of the switching inductor the switching frequency and the voltage ripple can be set.

The precise internal bandgap stabilizes the circuit and provides stable current conditions over temperature range.

To ensure a long lifetime of the LED system, the ILD4035 incorporates an overvoltage and an overcurrent protection.

In addition, the integrated thermal protection will reduce the output current to protect the LEDs and the IC against thermal stress.

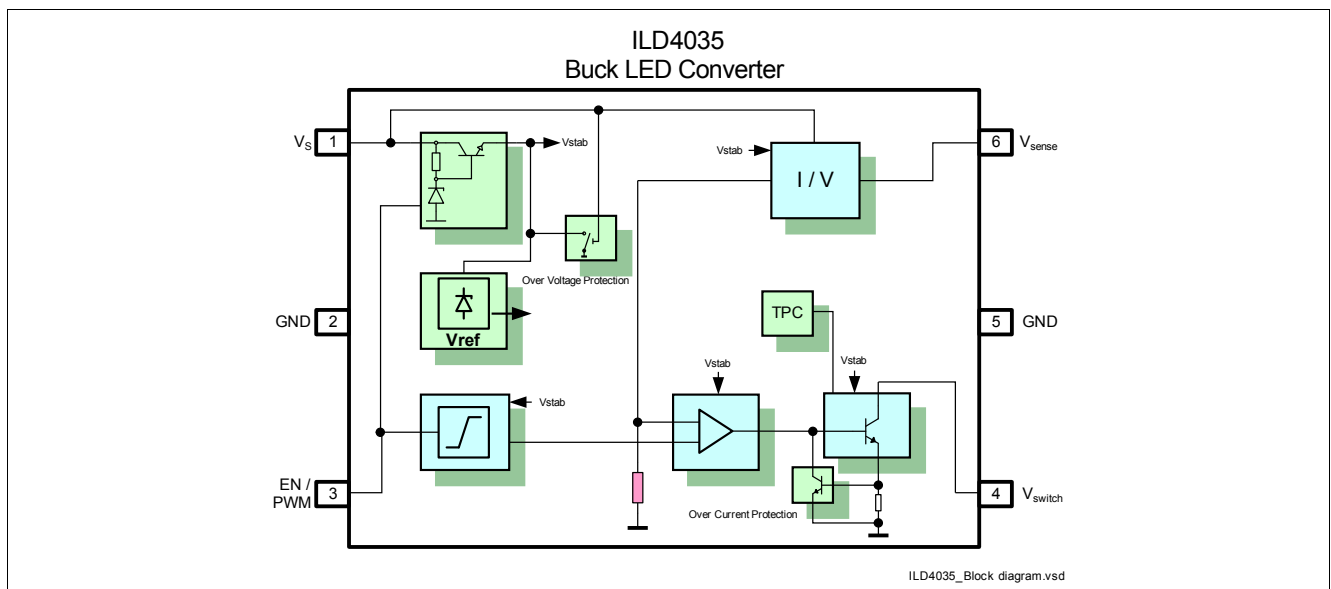

Figure 1 Block Diagram

Pin Definition

Table 1 Pin Definition and Function

Pin No.	Name	Pin Type	Buffer Type	Function
1	V_s	Input	–	Supply voltage
2	GND	GND	–	IC ground
3	EN / PWM	Input	–	Multifunctional pin: <ul style="list-style-type: none"> • Chip enable signal • Analog dimming signal • PWM dimming signal
4	V_{switch}	Output	–	Power switch output
5	GND	GND	–	IC ground
6	V_{sense}	Input	–	LED current sense input

3 Maximum Ratings

Table 2 Maximum Ratings

Parameter	Symbol	Values			Unit	Note / Test Condition
		Min.	Typ.	Max.		
Supply voltage	V_S	–	–	45	V	–
Peak output current	I_{Switch}	–	–	550	mA	Hysteretic peak current
Total power dissipation, $T_s \leq 85^\circ\text{C}$	P_{tot}	–	–	1000	mW	–
Junction temperature	T_J	–	–	150	$^\circ\text{C}$	–
Storage temperature range	T_{STG}	-65	–	150	$^\circ\text{C}$	–
ESD capability at all pins	$V_{ESD\ HBM}$	–	–	4	kV	HBM acc. to JESD22-A114

Attention: Stresses above the max. values listed here may cause permanent damage to the device. Exposure to absolute maximum rating conditions for extended periods may affect device reliability. Maximum ratings are absolute ratings; exceeding only one of these values may cause irreversible damage to the integrated circuit.

4 Thermal Characteristics

Table 3 Maximum Thermal Resistance

Parameter	Symbol	Values			Unit	Note / Test Condition
		Min.	Typ.	Max.		
Junction - soldering point ¹⁾	R_{thJS}	–	–	65	K/W	–

1) For calculation of R_{thJA} please refer to application note AN077 (Thermal Resistance Calculation)

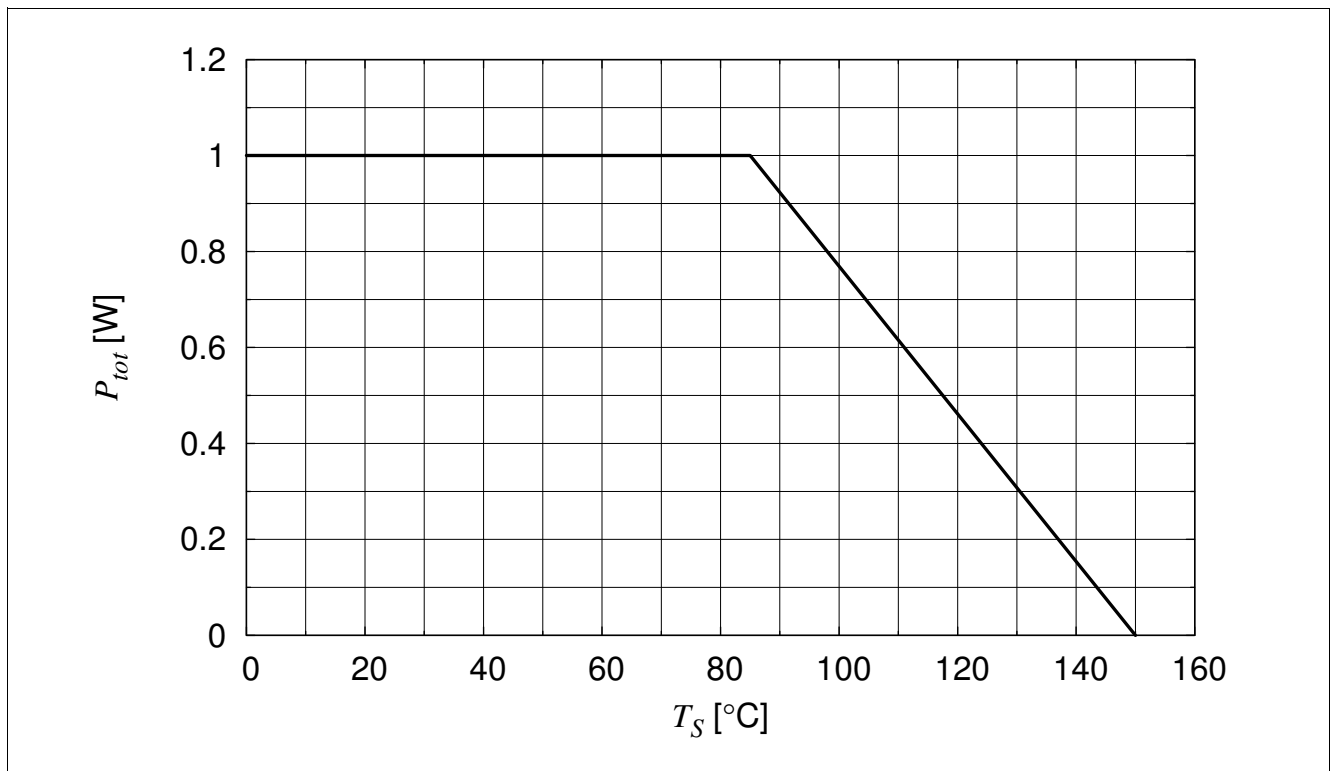

Figure 2 Total Power Dissipation

Equation (1) gives an estimation for the power dissipation of ILD4035.

$$P_{tot} = 1.1V \cdot I_{LED} \cdot duty\ cycle + f_{Switch} \cdot 1\ \mu W \cdot \frac{I_{LED}}{350\ mA}$$

(1)

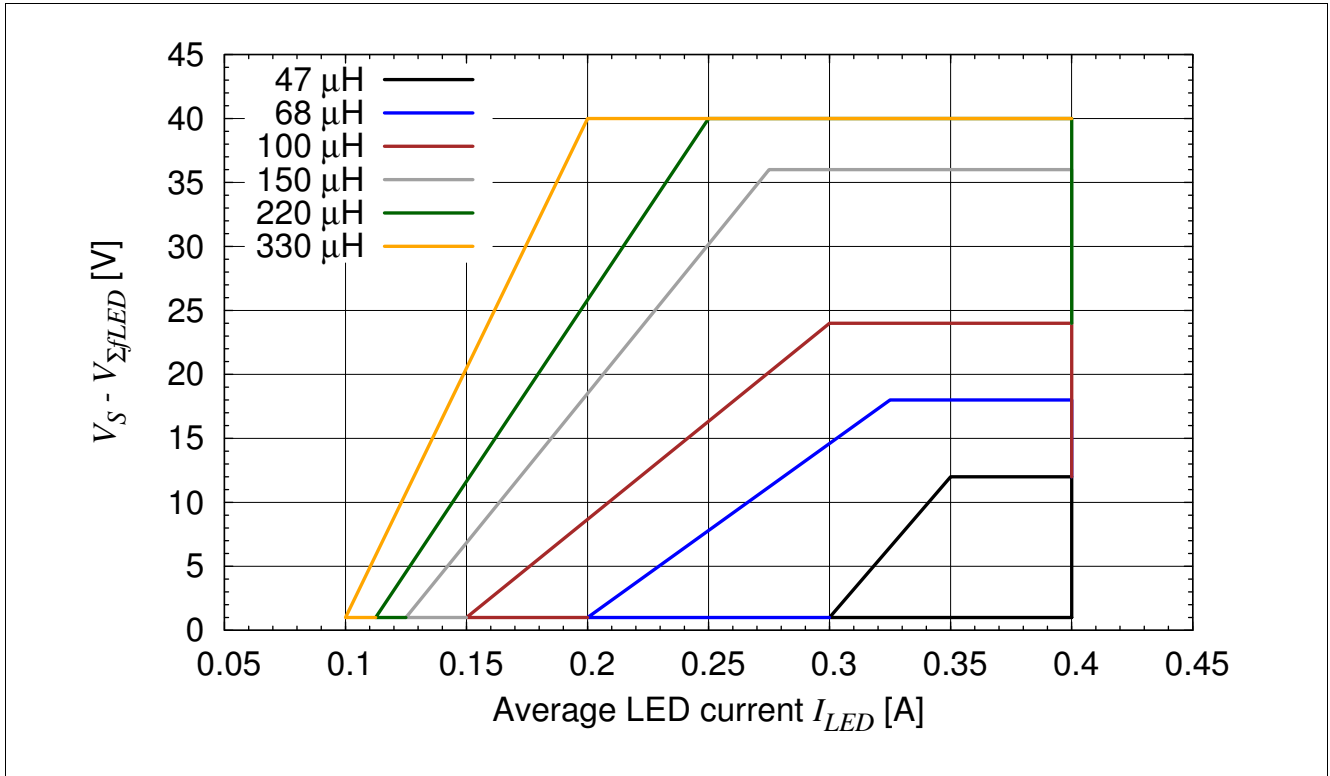

Figure 3 Safe Operating Area

Figure 3 shows the safe operating area for the respective inductance values. The safe operating area consists of the minimum and maximum allowed average LED current and the resulting voltage overhead. The voltage overhead $V_{overhead}$ is the difference between the supply voltage V_S and the sum of the LED forward voltages $V_{\Sigma LED}$.

Example calculation 1

3 LEDs in series, $V_{fLED} = 3V$, $I_{LED} = 350\text{ mA}$, $V_S = 12\text{ V}$

$$V_{overhead} = V_S - V_{\Sigma fLED} = 12\text{ V} - 9\text{ V} = 3\text{ V}$$

→ any of the above coil values can be used

Example calculation 2

6 LEDs in series, $V_{fLED} = 3V$, $I_{LED} = 250\text{ mA}$, $V_S = 24\text{ V}$

$$V_{overhead} = V_S - V_{\Sigma fLED} = 24\text{ V} - 18\text{ V} = 6\text{ V}$$

→ the coil values needs to be at least 68 μ H

Outside the safe operating area the switching frequency, hysteric peak current and associated power dissipation P_{tot} of ILD4035 will increase beyond the maximum ratings.

5 Electrical Characteristics

5.1 DC Characteristics

All parameters at $T_A = 25\text{ °C}$, unless otherwise specified.

$V_S = 12\text{ V}$, 3 LEDs, $R_{sense} = 303\text{ m}\Omega$ ($I_{LED} = 375\text{ mA}$), $L = 100\text{ }\mu\text{H}$, $V_{EN} = 3\text{ V}$, $V_{fLED} = 3\text{ V}$

Table 4 DC Characteristics

Parameter	Symbol	Values			Unit	Note / Test Condition
		Min.	Typ.	Max.		
Supply voltage	V_S	4.5	–	40	V	
Overall current consumption open load	$I_{S\ open\ load}$	1.4	2.3	3.1	mA	$V_S = 4.5\text{ V}$ $I_{LED} = 0\text{ mA}$
Overall current consumption open load	$I_{S\ open\ load}$	1.5	2.4	3.2	mA	$V_S = 12\text{ V}$ $I_{LED} = 0\text{ mA}$
Overall current consumption open load	$I_{S\ open\ load}$	1.8	3.0	3.9	mA	$V_S = 40\text{ V}$ $I_{LED} = 0\text{ mA}$
Overall standby current consumption	$I_{S\ standby}$	–	–	1	μA	$V_{EN} = 0\text{ V}$; $V_S = 12\text{ V}$
Overall standby current consumption	$I_{S\ standby}$	–	–	5	μA	$V_{EN} = 0\text{ V}$; $V_S = 40\text{ V}$
Enable voltage for standby mode	V_{EN}	-0.3	–	0.4	V	
Enable voltage for analog dimming	V_{EN}	1	–	2	V	linear dimming range
Input current of multifunctional control pin	I_{EN}	–	50	140	μA	$V_{EN} = 3\text{ V}$ $V_S = 4.5..40\text{ V}$
Current of sense input	I_{sense}	–	20	–	μA	at any LED current
Over temperature protection	$T_{S,TSD}$	–	113	–	$^{\circ}\text{C}$	T_S for 10 % I_{LED} reduction, defined by T_J

5.2 Switching Characteristics

All parameters at $T_A = 25\text{ }^\circ\text{C}$, unless otherwise specified.

$V_S = 12\text{ V}$, 3 LEDs, $R_{sense} = 303\text{ m}\Omega$ ($I_{LED} = 375\text{ mA}$), $L = 100\text{ }\mu\text{H}$, $V_{EN} = 3\text{ V}$, $V_{fLED} = 3\text{ V}$

Table 5 Switching Characteristics

Parameter	Symbol	Values			Unit	Note / Test Condition
		Min.	Typ.	Max.		
Switching frequency	f_{Switch}	–	120	–	kHz	
Maximum switching frequency	$f_{Switch\ max}$	–	–	500	kHz	for any coil value
Mean current sense threshold voltage	V_{sense}	–	114	–	mV	
Sense threshold hysteresis	$V_{sensehys}$	–	± 7.5	–	%	
Residual voltage at collector of power transistor	$V_{switch\ on}$	–	1.1	–	V	output switch turned on
Output current accuracy	I_{outacc}	–	± 3	–	%	

5.3 Digital Signals

All parameters at $T_A = 25\text{ }^\circ\text{C}$, unless otherwise specified.

Table 6 Digital Control Parameter at Pin EN/PWM

Parameter	Symbol	Values			Unit	Note / Test Condition
		Min.	Typ.	Max.		
Input voltage for power on	V_{On}	2.5	3	40	V	full LED current
Input voltage for power off	V_{Off}	-0.3	–	0.4	V	
Min. power on puls duration	t_{On}	10	–		μs	

6 Basic Application Information

This section covers the basic information required for calculating the parameters for a certain LED application. For detailed application information please check the Application Note **AN215** (Driving 1 W LEDs with IL4035) or visit our web site <http://www.infineon.com/led.appnotes>

6.1 Setting the average LED current

The average output current for the LEDs is set by the external sense resistor R_{sense} . To calculate the value of this resistor a first approximation can be calculated using **Equation (2)**.

V_{sense} is dependent on the supply voltage V_S and the number of LEDs in series.

$$R_{sense} = \frac{V_{sense}}{I_{LED}} \quad (2)$$

Example calculation 1

$V_S = 12\text{ V}$, $100\ \mu\text{H}$, $V_{fLED} = 3\text{ V}$, 3 LEDs in series

→ $V_{sense} = 114\text{ mV}$

$I_{LED} = 375\text{ mA}$

→ $R_{sense} = 303\text{ m}\Omega$

Example calculation 2

$V_S = 24\text{ V}$, $100\ \mu\text{H}$, $V_{fLED} = 3\text{ V}$, 6 LEDs in series

→ $V_{sense} = 106\text{ mV}$

$I_{LED} = 350\text{ mA}$

→ $R_{sense} = 303\text{ m}\Omega$

An easy way to achieve these resistor values is to connect standard resistors in parallel

6.2 Dimming of the LEDs

Analog voltage dimming

The voltage level of the EN/PWM pin can be used for analog dimming of the LED current. To achieve a linear change in LED current versus control voltage the recommended voltage range at the EN/PWM pin is 1 V to 2 V. The maximum achievable LED current is defined by resistor R_{sense} . The maximum LED current will be achieved for $V_{EN} \geq 2.5\text{ V}$. Below 0.4 V the IL4035 is set to standby mode and the output is switched off. The typical dimming performance is shown in below figures.

I_{LED} versus V_{EN} , $T_A=25\text{ }^\circ\text{C}$

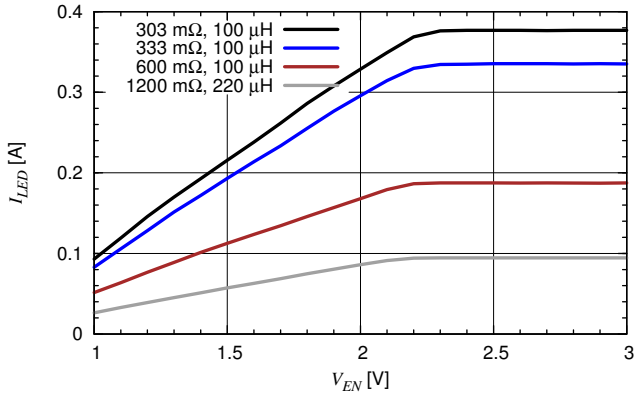

I_{LED} (relative) versus V_{EN} , $T_A=25\text{ }^\circ\text{C}$

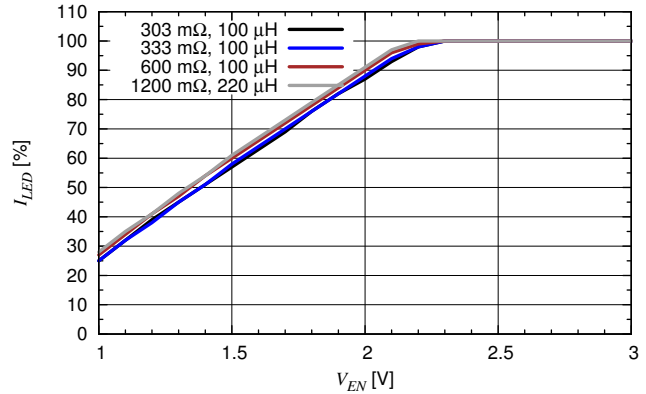

I_{LED} versus V_{EN} , 333 mΩ, 100 μH

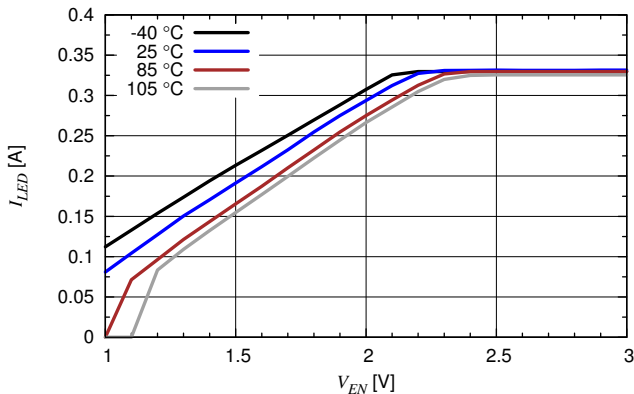

PWM Dimming

Besides the analog dimming functionality the EN/PWM pin acts as input for a pulse width modulated (PWM) signal to control the dimming of the LED string. For PWM dimming the signal's logic high level should be at least 2.5 V and the PWM frequency should be lower than 5 kHz. For the ILD4035/4001 demo board a dimming frequency less than 330 Hz is recommended to maintain a maximum contrast ratio of 100:1. The achievable contrast ratio is shown on [Figure 4](#) based on the measured average LED current deviating 3 dB from the linear reference. The maximum contrast ratio depends mainly on the rise time of the inductor current and is thus dependent on supply voltage, inductor size and LED string forward voltage.

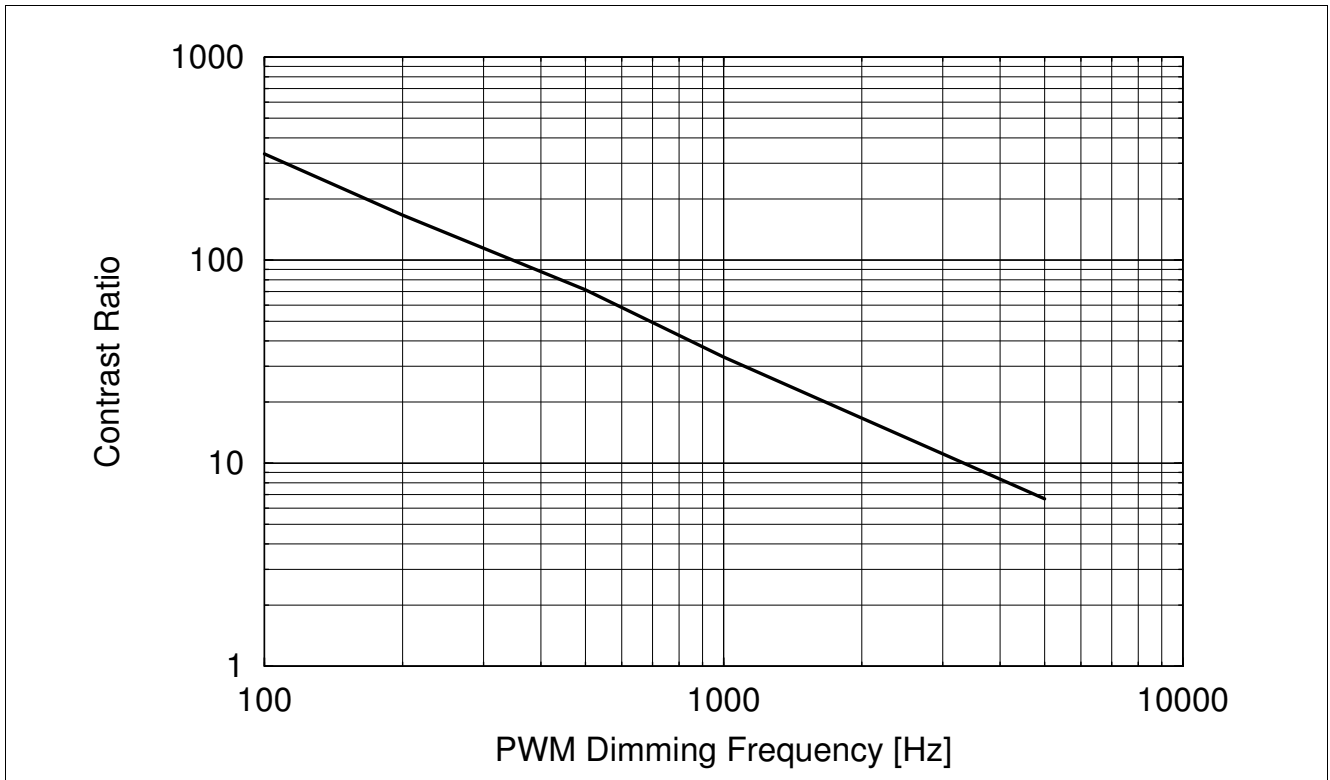

Figure 4 PWM Dimming

6.3 Temperature Protection Circuit

ILD4035 incorporates a temperature protection circuit referring to the junction temperature of ILD4035. The higher the junction temperature of ILD4035 the lower the current of the LEDs. This feature helps to reduce the power dissipation of ILD4035 and the LEDs. Yet still the product specific maximum ratings for junction temperature need to be observed to avoid a permanent damage of the devices.

ILD4035 has been characterized on ILD4035/4001 application board heated from the backside without additional air flow on the circuit board surface besides natural convection. Design and layout of the circuit board as well as the air flow influence the thermal resistance junction to ambient R_{thJA} of ILD4035 and thus its junction temperature. Below figures show the LED current versus soldering point temperature T_S .

LED current versus T_S , $V_S = 12\text{ V}$

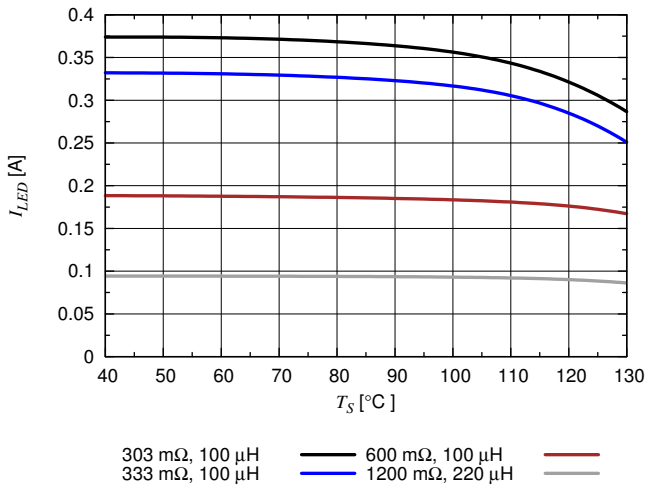

LED current (relative) versus T_S , $V_S = 12\text{ V}$

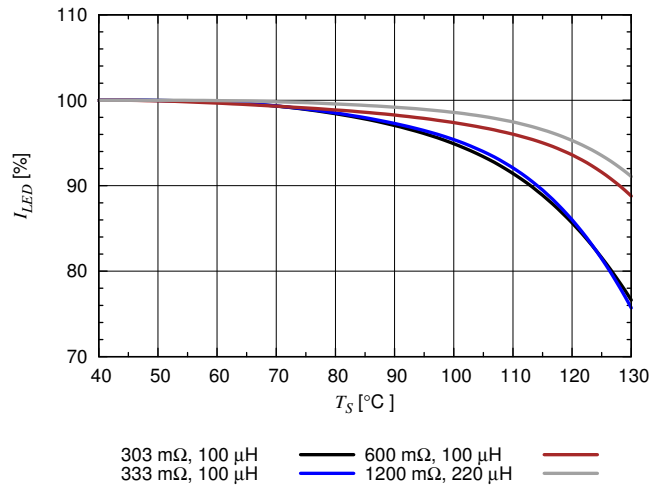

6.4 Switching Parameters

For all shown parameters ILD4035 has been measured on evaluation board ILD4035/4001 at $T_A = 25\text{ °C}$. Used LEDs have a typical forward voltage V_{fLED} of 3 V. For details see application note **AN215** (Driving 1W LEDs with ILD4035) or visit our web site <http://www.infineon.com/lowcostledrivers>.

$R_{sense} = 303 \text{ m}\Omega$, $L = 47 \text{ }\mu\text{H}$

I_{LED} versus V_S and Number of LEDs

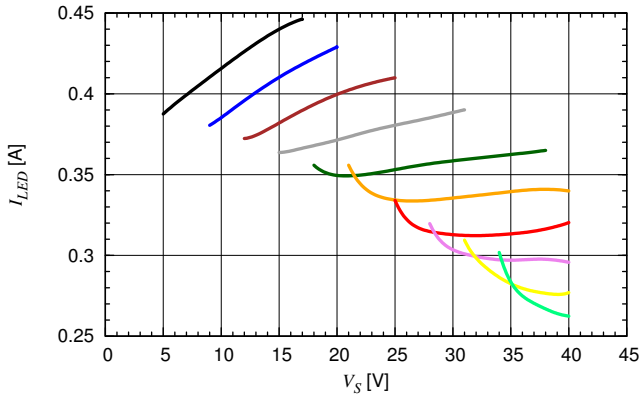

f_{Switch} versus V_S and Number of LEDs

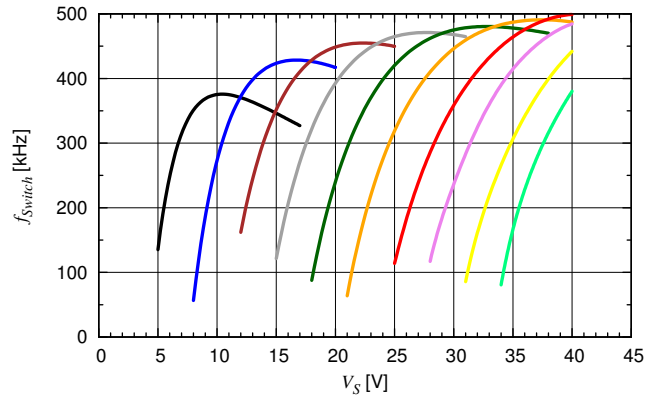

Efficiency versus V_S and Number of LEDs

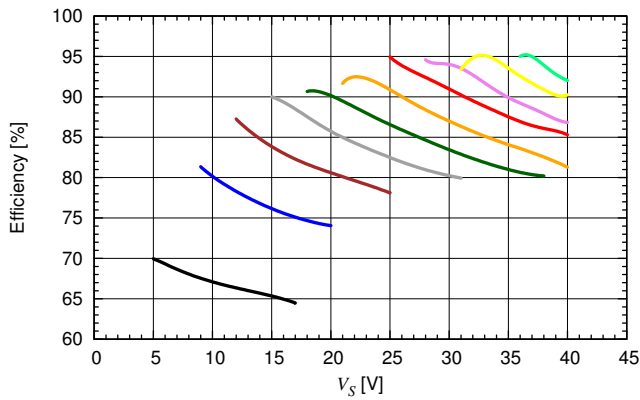

Duty Cycle versus V_S and Number of LEDs

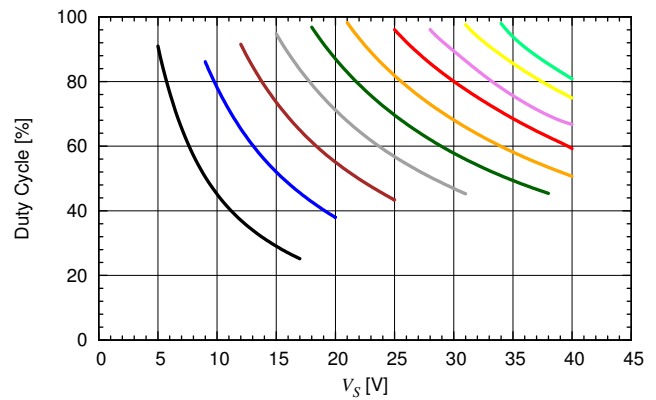

$R_{sense} = 303\text{ m}\Omega$, $L = 68\text{ }\mu\text{H}$

I_{LED} versus V_S and Number of LEDs

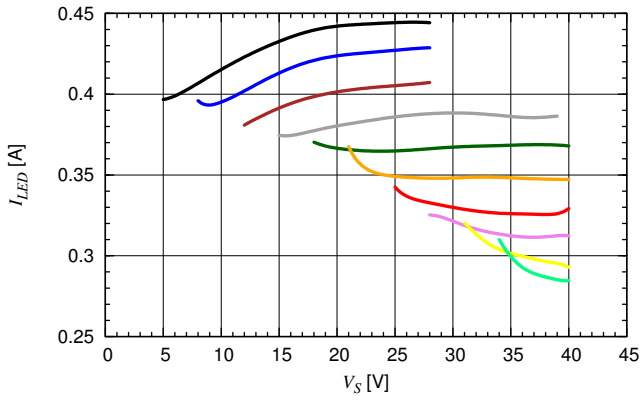

f_{Switch} versus V_S and Number of LEDs

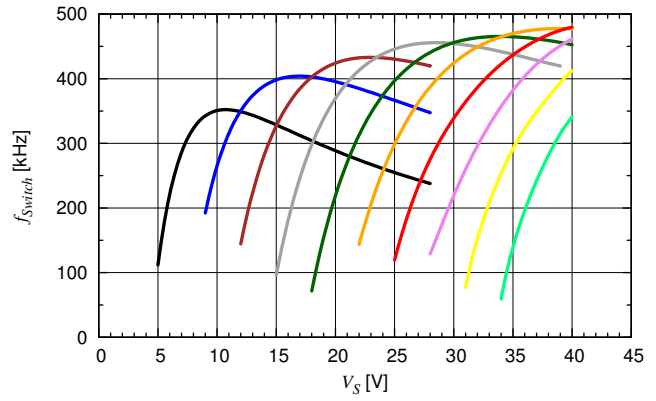

Efficiency versus V_S and Number of LEDs

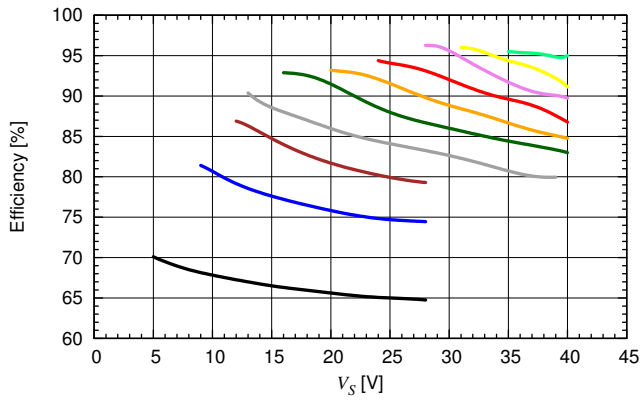

Duty Cycle versus V_S and Number of LEDs

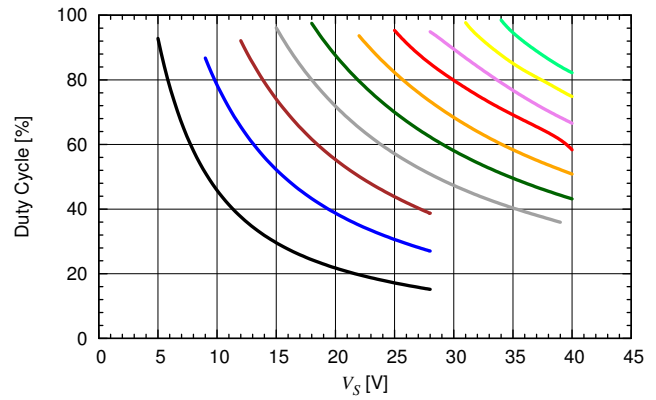

$R_{sense} = 303 \text{ m}\Omega$, $L = 100 \text{ }\mu\text{H}$

I_{LED} versus V_S and Number of LEDs

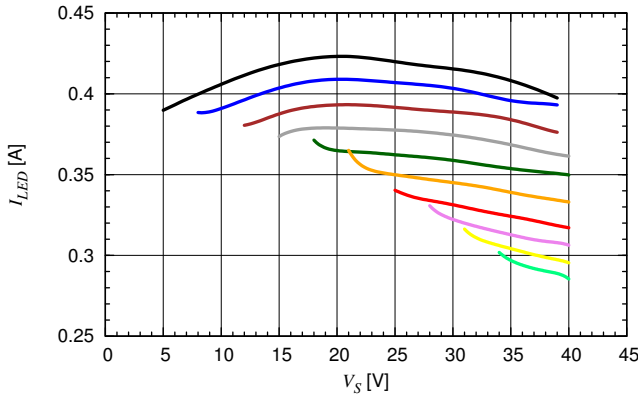

f_{Switch} versus V_S and Number of LEDs

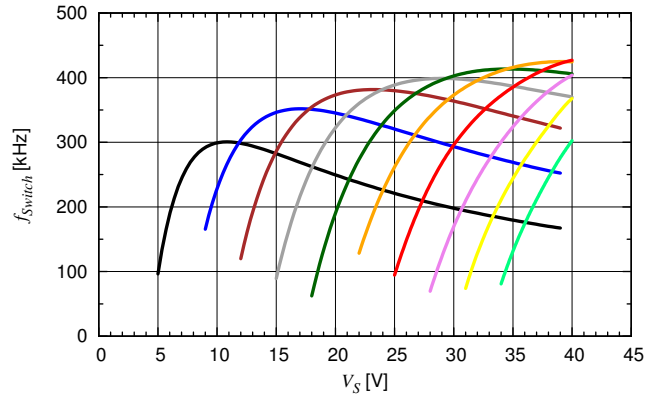

Efficiency versus V_S and Number of LEDs

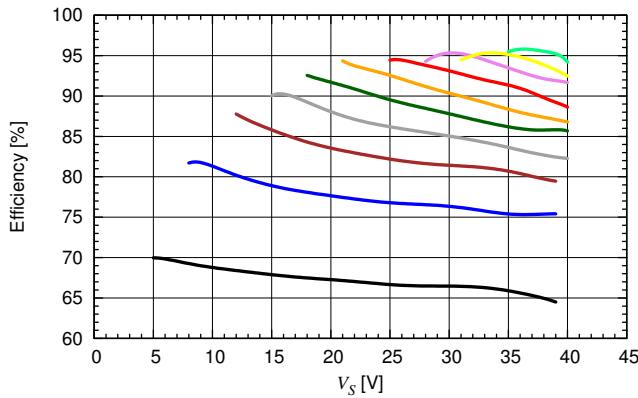

Duty Cycle versus V_S and Number of LEDs

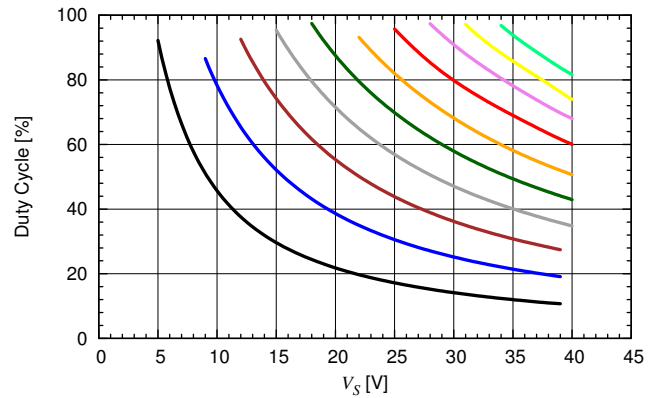

$R_{sense} = 303 \text{ m}\Omega$, $L = 220 \text{ }\mu\text{H}$

I_{LED} versus V_S and Number of LEDs

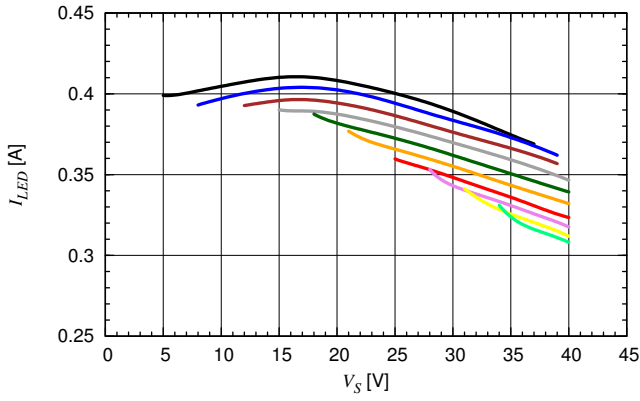

f_{Switch} versus V_S and Number of LEDs

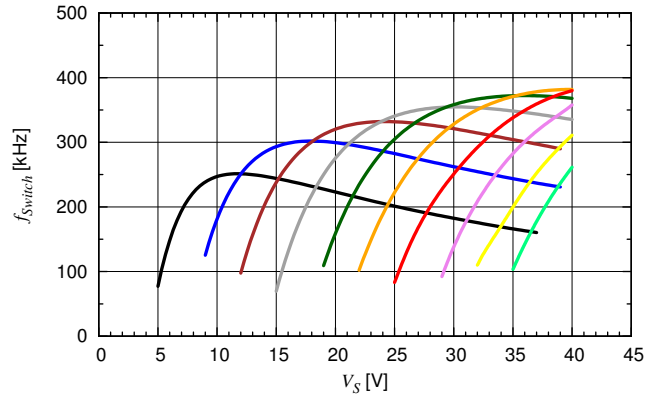

Efficiency versus V_S and Number of LEDs

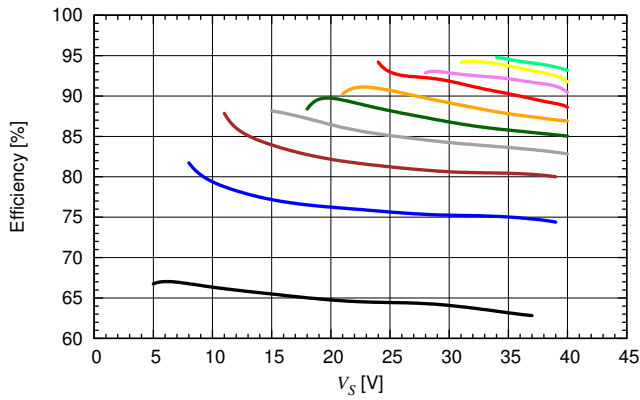

Duty Cycle versus V_S and Number of LEDs

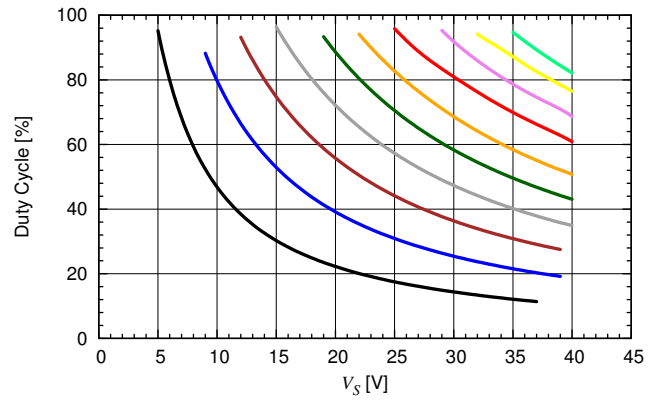

$R_{sense} = 367 \text{ m}\Omega$, $L = 47 \text{ }\mu\text{H}$

I_{LED} versus V_S and Number of LEDs

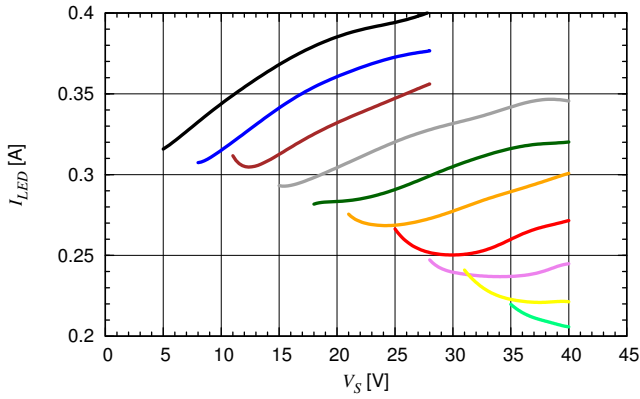

f_{Switch} versus V_S and Number of LEDs

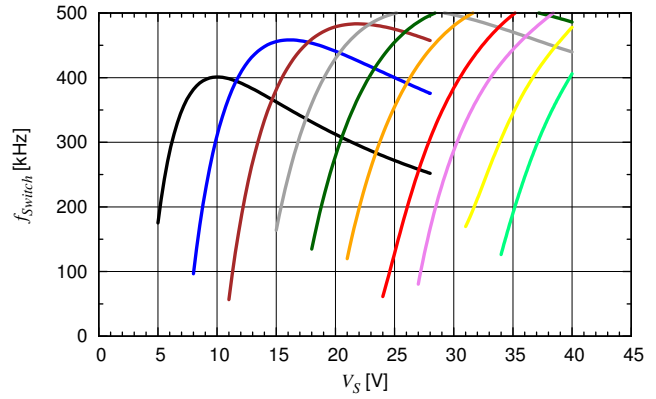

Efficiency versus V_S and Number of LEDs

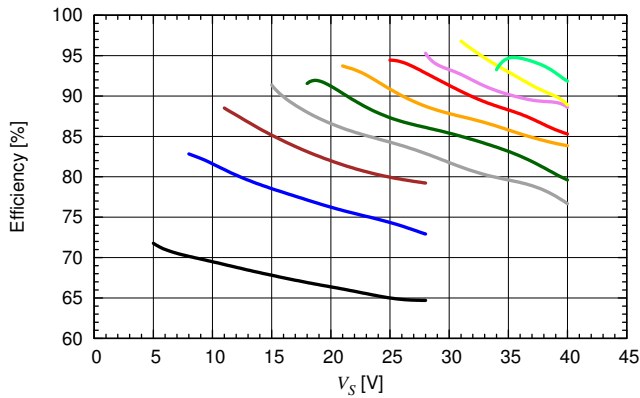

Duty Cycle versus V_S and Number of LEDs

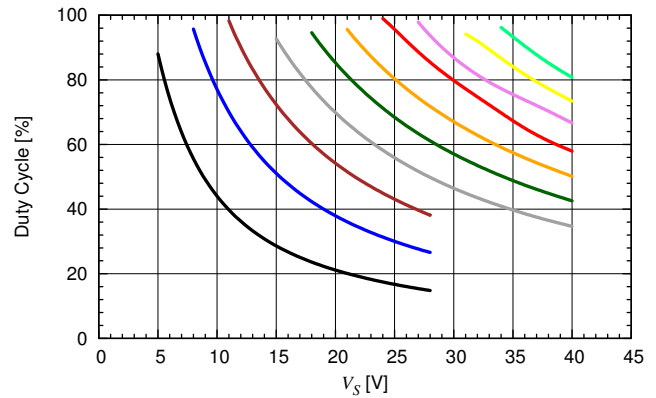

$R_{sense} = 367 \text{ m}\Omega$, $L = 68 \text{ }\mu\text{H}$

I_{LED} versus V_S and Number of LEDs

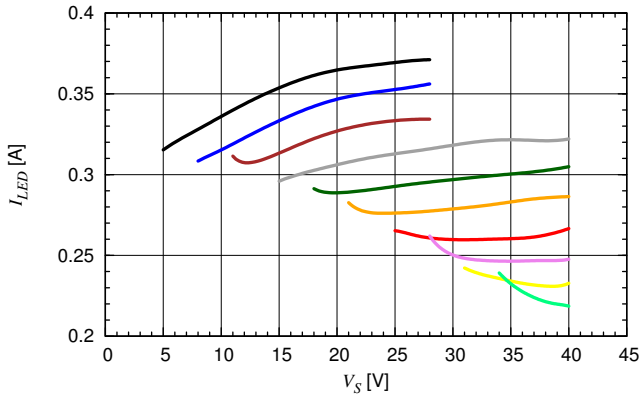

f_{Switch} versus V_S and Number of LEDs

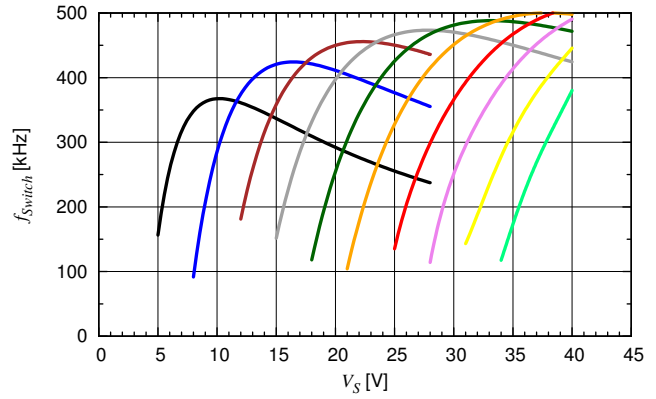

Efficiency versus V_S and Number of LEDs

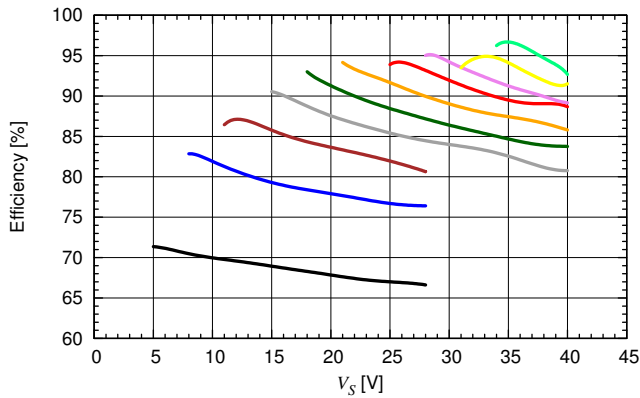

Duty Cycle versus V_S and Number of LEDs

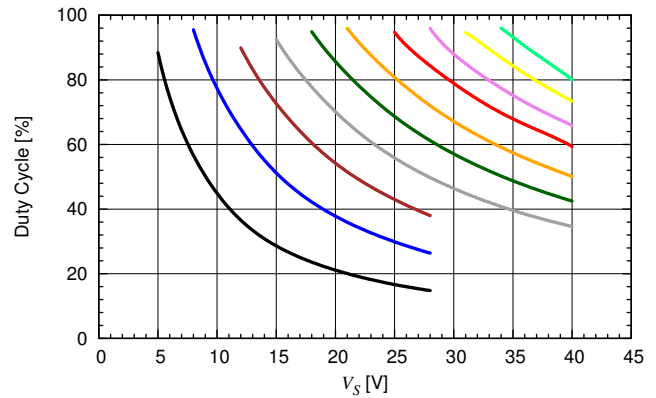

$R_{sense} = 367\text{ m}\Omega$, $L = 100\text{ }\mu\text{H}$

I_{LED} versus V_S and Number of LEDs

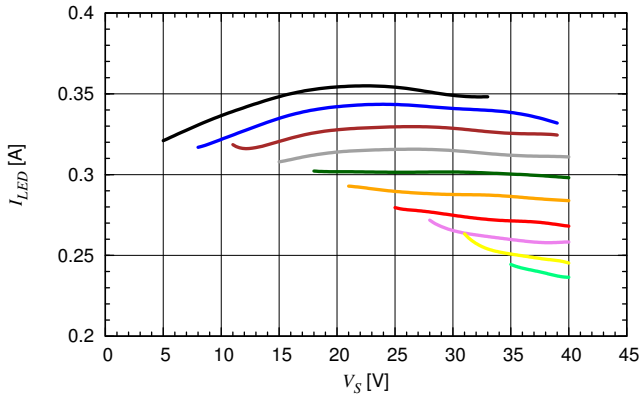

f_{Switch} versus V_S and Number of LEDs

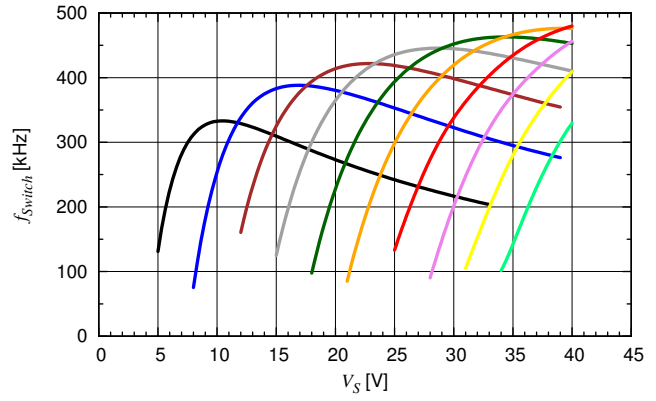

Efficiency versus V_S and Number of LEDs

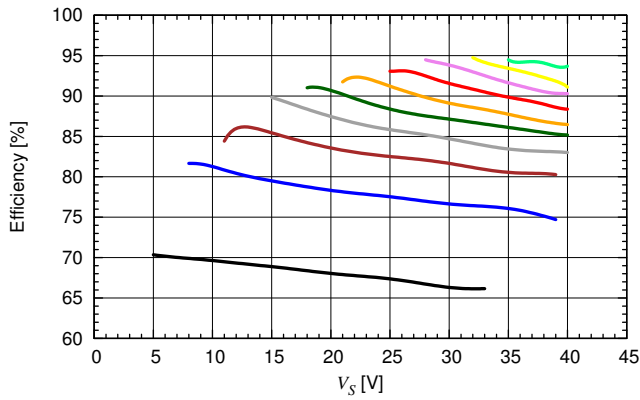

Duty Cycle versus V_S and Number of LEDs

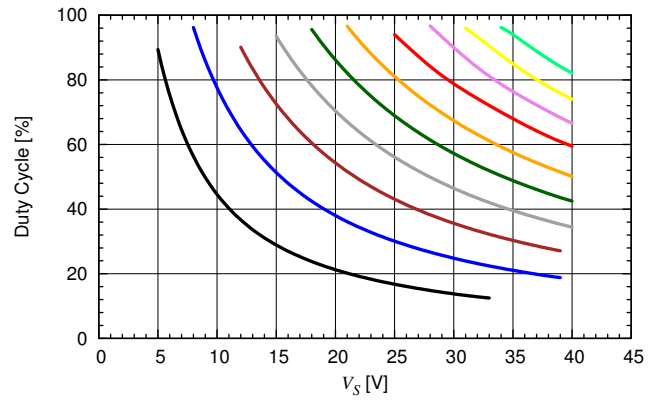

$R_{sense} = 367\text{ m}\Omega$, $L = 220\text{ }\mu\text{H}$

I_{LED} versus V_S and Number of LEDs

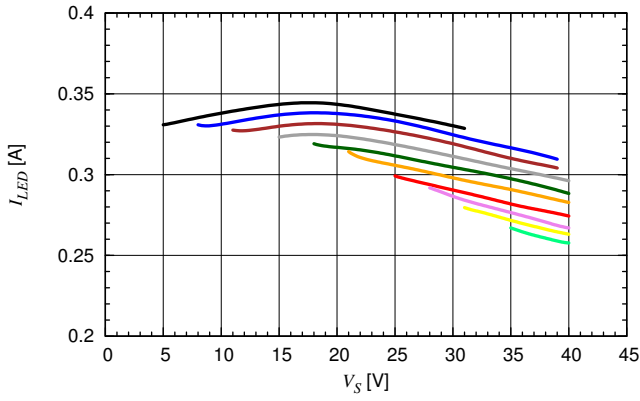

f_{Switch} versus V_S and Number of LEDs

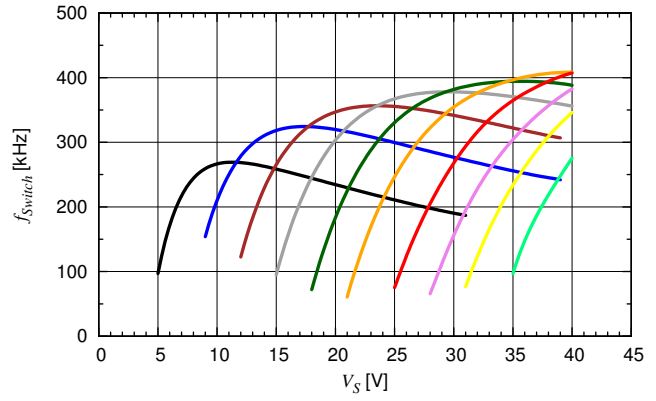

Efficiency versus V_S and Number of LEDs

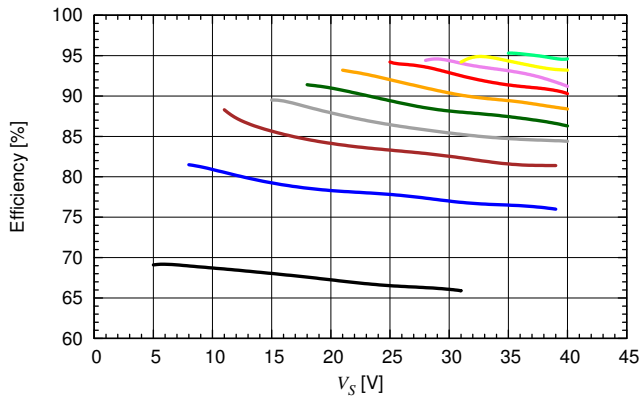

Duty Cycle versus V_S and Number of LEDs

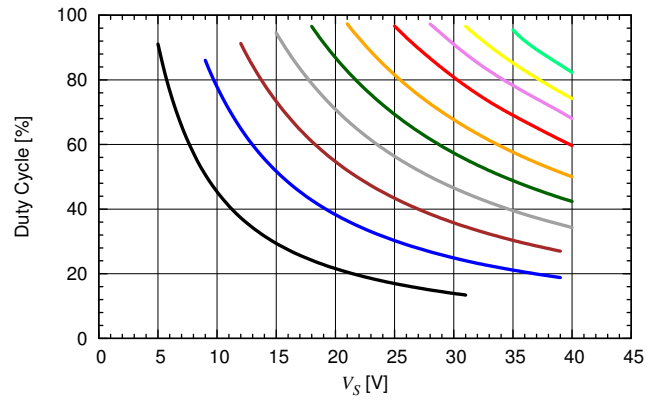

7 Application Circuit

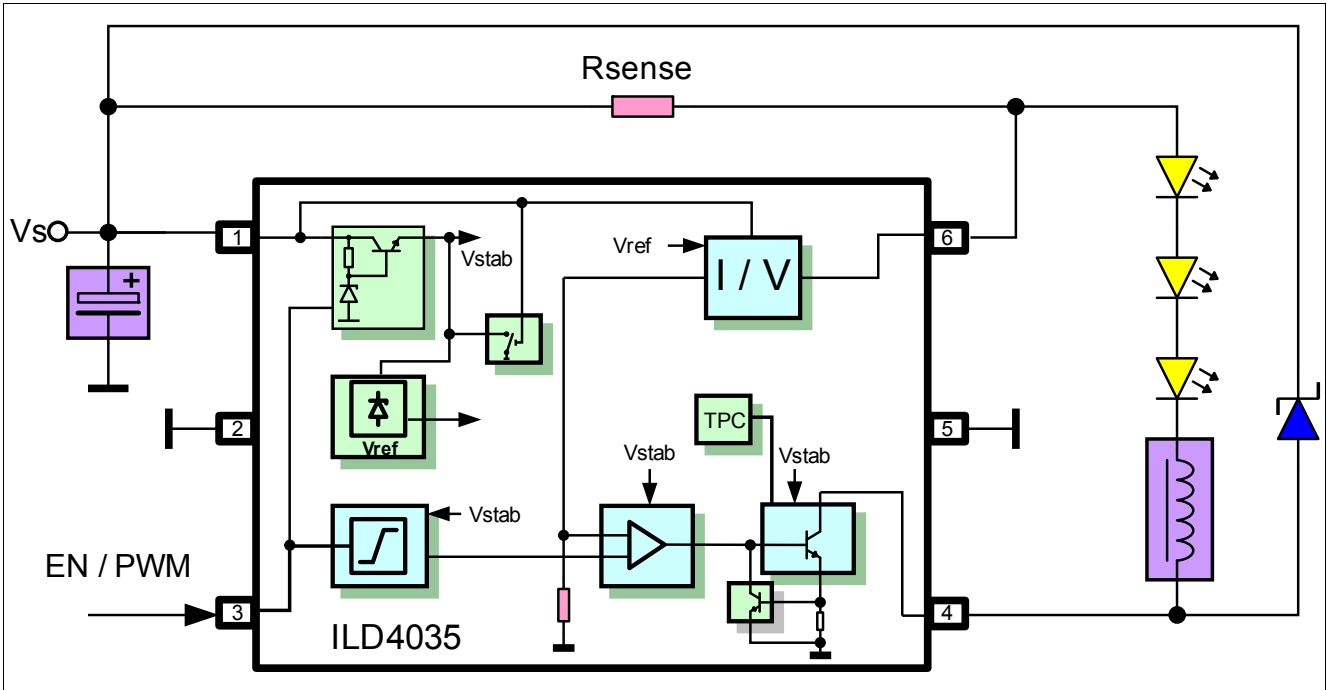

Figure 5 Application Circuit

8 Evaluation Board

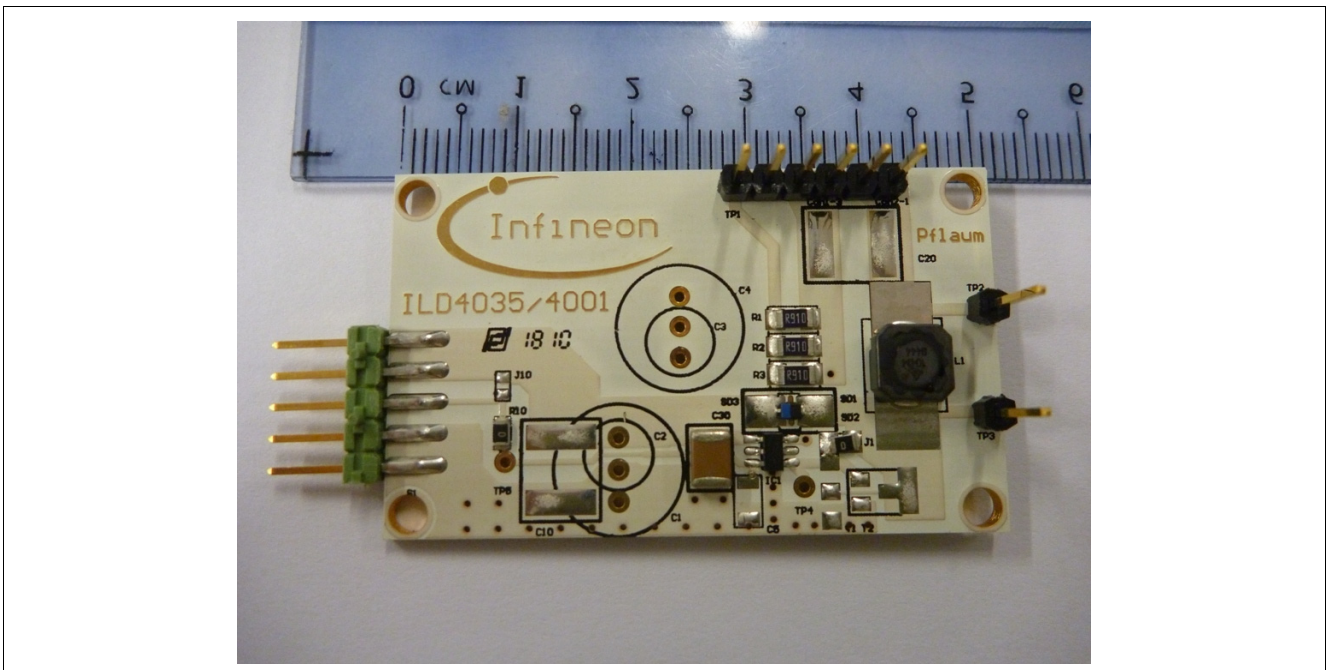

Figure 6 ILD4035 on Evaluation Board

9 Package Information

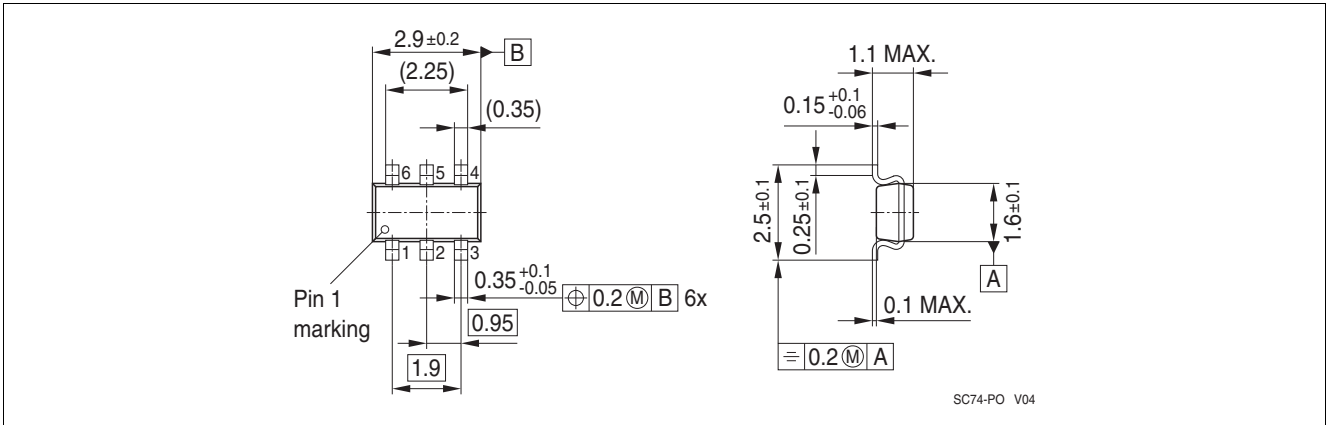

Figure 7 Package Outline SC74

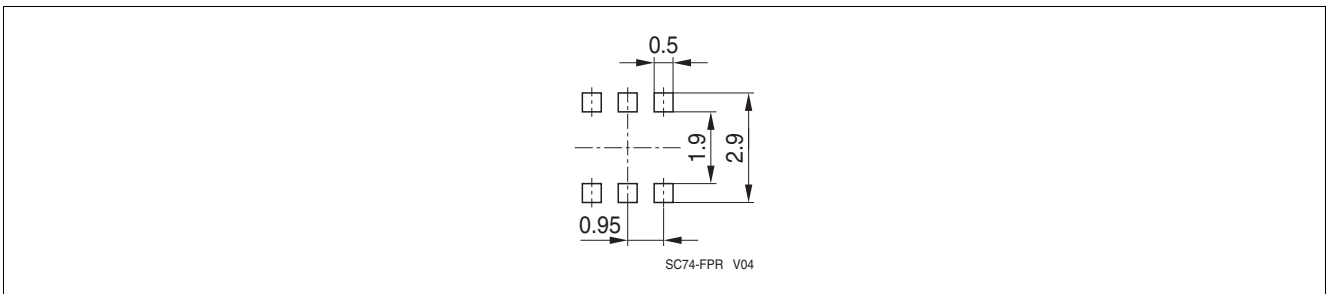

Figure 8 Recommended PCB Footprint for Reflow Soldering

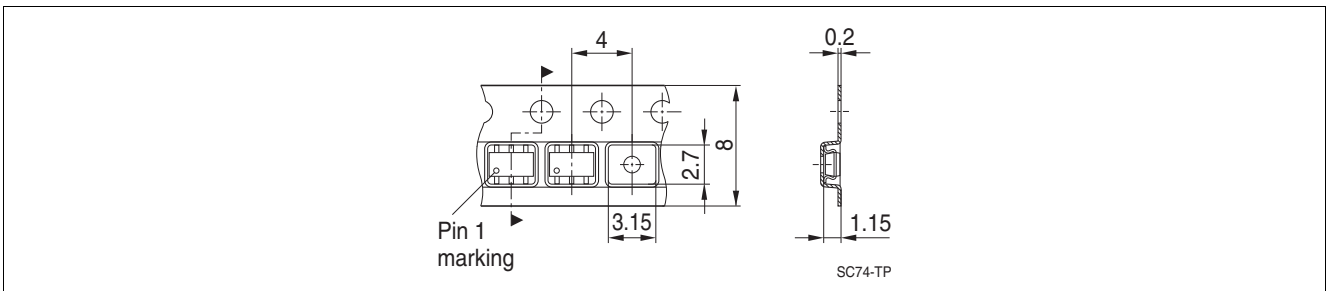

Figure 9 Tape Loading

www.infineon.com

Published by Infineon Technologies AG