

CMPA0060002D

2 Watt, 20 MHz - 6000 MHz GaN HEMT MMIC Power Amplifier

Cree's CMPA0060002D is a gallium nitride (GaN) High Electron Mobility Transistor (HEMT) based monolithic microwave integrated circuit (MMIC). GaN has superior properties compared to silicon or gallium arsenide, including higher breakdown voltage, higher saturated electron drift velocity and higher thermal conductivity. GaN HEMTs also offer greater power density and wider bandwidths compared to Si and GaAs transistors. This MMIC employs a distributed (traveling-wave) amplifier design approach, enabling extremely wide bandwidths to be achieved in a small footprint.

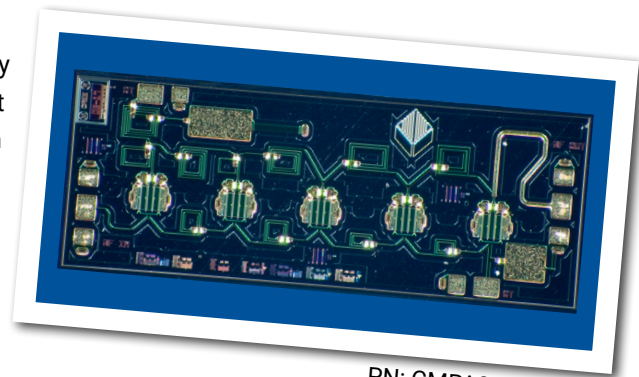

PN: CMPA0060002D

Typical Performance Over 0.5-6.0 GHz ($\tau_c = 25^\circ\text{C}$)

Parameter	0.5 GHz	1.0 GHz	2.5 GHz	4.0 GHz	6.0 GHz	Units
Gain	18.7	17.4	17.6	17.4	17.6	dB
Saturated Output Power @ P_{IN} 23 dBm	7.0	6.3	5.7	4.3	3.6	W
Power Gain @ P_{IN} 23 dBm	15.4	15.0	14.5	13.3	12.5	dB
PAE @ P_{IN} 23 dBm	43	40	36	28	31	%

Note: $V_{DD} = 28\text{ V}$, $I_D = 100\text{ mA}$

Features

- 17 dB Small Signal Gain
- 2 W Typical P_{SAT}
- Operation up to 28 V
- High Breakdown Voltage
- High Temperature Operation
- Size 0.169 x 0.066 x 0.004 inches

Applications

- Ultra Broadband Amplifiers
- Fiber Drivers
- Test Instrumentation
- EMC Amplifier Drivers

Absolute Maximum Ratings (not simultaneous) at 25°C

Parameter	Symbol	Rating	Units
Drain-source Voltage	V_{DSS}	84	VDC
Gate-source Voltage	V_{GS}	-10, +2	VDC
Storage Temperature	T_{STG}	-65, +150	°C
Operating Junction Temperature	T_J	225	°C
Maximum Forward Gate Current	I_{GMAX}	2	mA
Thermal Resistance, Junction to Case (packaged) ¹	$R_{\theta JC}$	4.0	°C/W

Note¹ Eutectic die attach using 80/20 AuSn mounted to a 40 mil thick CuW carrier.

Electrical Characteristics (Frequency = 20 MHz to 6,000 MHz unless otherwise stated; $T_c = 25^\circ\text{C}$)

Characteristics	Symbol	Min.	Typ.	Max.	Units	Conditions
DC Characteristics						
Gate Threshold Voltage ¹	$V_{(GS)TH}$	-3.8	-3.0	-2.7	V	$V_{DS} = 20\text{ V}, \Delta I_D = 2\text{ mA}$
Gate Quiescent Voltage	$V_{GS(Q)}$	-	-2.7	-	VDC	$V_{DD} = 26\text{ V}, I_{DQ} = 100\text{ mA}$
Saturated Drain Current ²	I_{DS}	-	1.94	-	A	$V_{DS} = 6.0\text{ V}, V_{GS} = 2.0\text{ V}$
RF Characteristics⁵						
Small Signal Gain ³	S21	13.5	18	-	dB	$V_{DD} = 26\text{ V}, I_{DQ} = 100\text{ mA}$
Input Return Loss	S11	-	9	-	dB	$V_{DD} = 26\text{ V}, I_{DQ} = 100\text{ mA}$
Output Return Loss	S22	-	11	-	dB	$V_{DD} = 26\text{ V}, I_{DQ} = 100\text{ mA}$
Output Power ⁴	P_{OUT}	2	4	-	W	$V_{DD} = 26\text{ V}, I_{DQ} = 100\text{ mA}, P_{IN} = 23\text{ dBm}$
Power Added Efficiency	PAE	-	30	-	%	$V_{DD} = 26\text{ V}, I_{DQ} = 100\text{ mA}, P_{IN} = 23\text{ dBm}$
Power Gain	G_p	-	13.0	-	dB	$V_{DD} = 26\text{ V}, I_{DQ} = 100\text{ mA}, P_{IN} = 23\text{ dBm}$
Output Mismatch Stress	VSWR	-	-	5 : 1	Ψ	No damage at all phase angles, $V_{DD} = 26\text{ V}, I_{DQ} = 100\text{ mA}, P_{IN} = 23\text{ dBm}$

Notes:

¹ The device will draw approximately 20-25 mA at pinch off due to the internal circuit structure.

² Scaled from PCM data.

³ The lowest test frequency is 1.0 GHz due to the lack of a low frequency termination.

⁴ Test frequencies 1.0, 2.5, and 4.0 GHz.

⁵ All data pulsed with Pulse Width = 10 μsec , Duty Cycle = 0.1%.

Die Dimensions (units in microns)

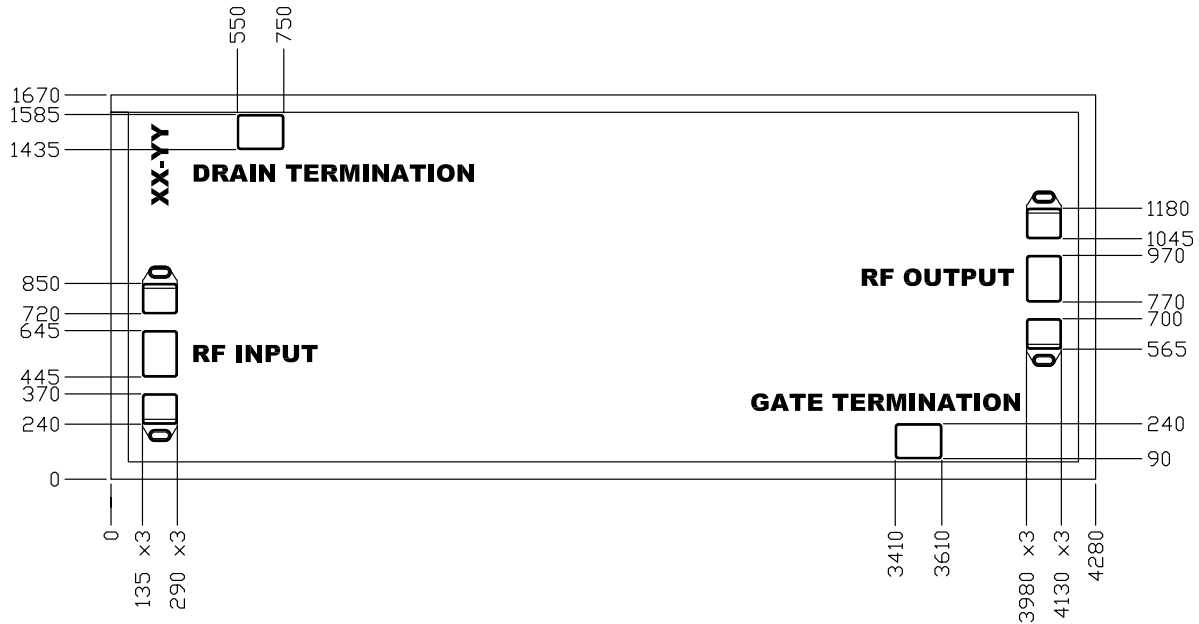

Overall die size 4280 x 1670 (+0/-50) microns, die thickness 100 (+/-10) micron.
All Gate and Drain pads must be wire bonded for electrical connection.

Pad Number	Function	Description	Pad Size (microns)
1	RF IN ¹	RF-Input pad. Matched to 50 ohm. Requires gate control from an external bias -T from -2.3 V to -3.8 V.	200 x 150
2	Gate Termination	Off Chip termination for the Gate. It needs to be DC-blocked .	200 x 150
3	Drain Termination	Off Chip termination for the Drain. It needs to be DC-blocked.	200 x 150
4	RF OUT ¹	RF-Output pad. Matched to 50 ohm. Requires Drain supply from an external bias -T up to 26 V , 800 mA	200 x 150

Notes:

¹ The RF In and Out pads have a ground-signal-ground configuration with a pitch of 1 mil (25 um)..

Die Assembly Notes:

- Recommended solder is AuSn (80/20) solder. Refer to Cree's website for the Eutectic Die Bond Procedure application note at www.cree.com/RF/Document-Library
- Vacuum collet is the preferred method of pick-up.
- The backside of the die is the Source (ground) contact.
- Die back side gold plating is 5 microns thick minimum.
- Thermosonic ball or wedge bonding are the preferred connection methods.
- Gold wire must be used for connections.
- Use the die label (XX-YY) for correct orientation.

Functional Block Diagram

This device employs a wideband, traveling wave amplifier topology. It has an internal termination for both the Drain and the Gate, which works well over 2.5-6.0 GHz. For operation below 2.5 GHz an external termination is required. This termination needs to be DC-blocked and suitable to withstand up to 3 W of RF power. (Refer to the reference design section for the LF-termination in this data sheet for more details). The circuits also require external wideband Bias -T's to supply voltage to the Gate and Drain. The Bias-T at the Drain needs to be designed to handle 28 V and up to 800 mA.

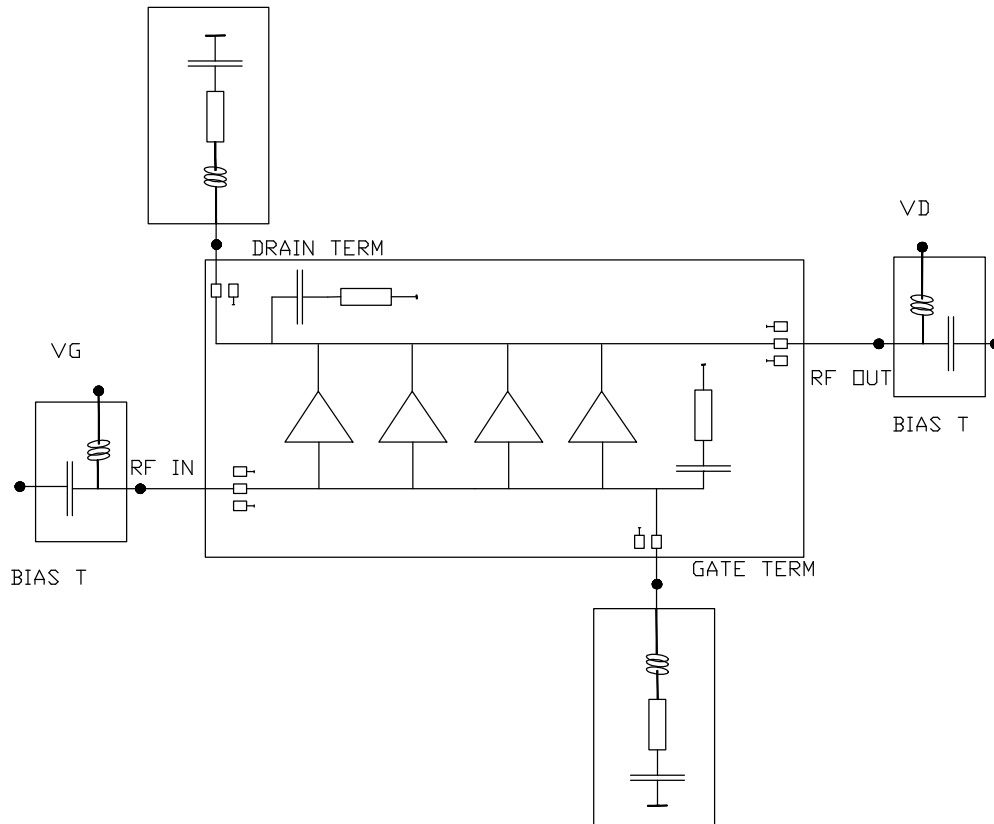
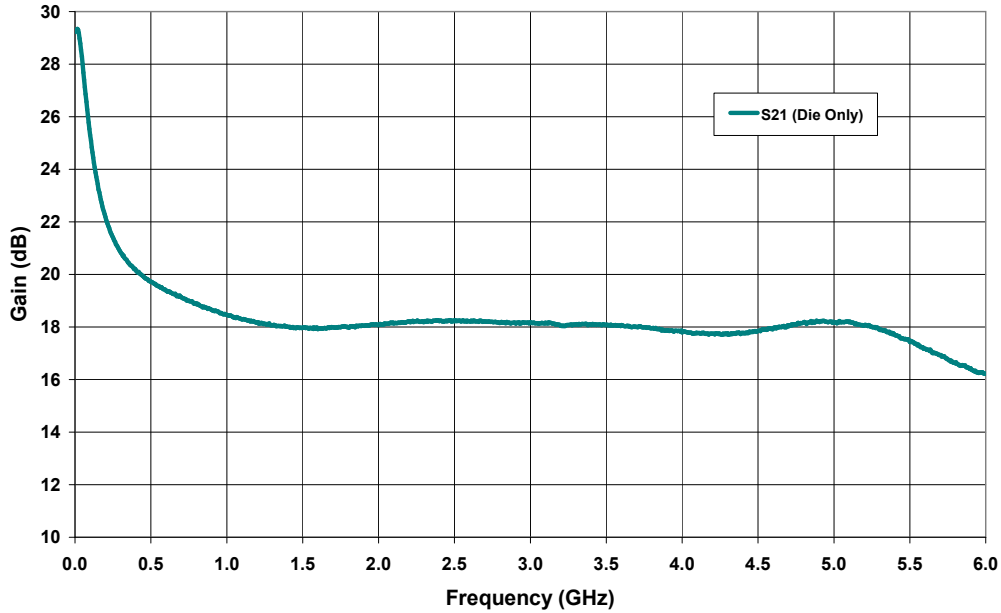

Figure 1.

External Termination Reference Design

The following is a plot of the gain of the die only.



Notes:

- ¹ An off chip termination is needed to reduce the high gain peak at low frequencies.
- ² The off chip termination should be designed to minimize the impact on the MMIC's performance at higher frequencies.

LRC Reference Circuit

The Drain and Gate circuit use the same L and C components but different values for the resistor.

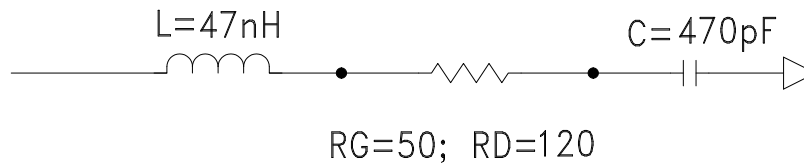

The Drain resistor needs to be dimensioned to handle 3 W of RF dissipation for the lowest frequencies while the Gate resistor needs to handle 0.5 W. The suppliers of the SMT components are:

L1 = 47 nH, CoilCraft PN: 0402CS -47NXJB

C1 = 470 pf Murata PN: GRM1885C2A471A01D

Typical Performance

Power Gain vs Frequency
 $V_{DD} = 28\text{ V}$, $P_{IN} = 23\text{ dBm}$

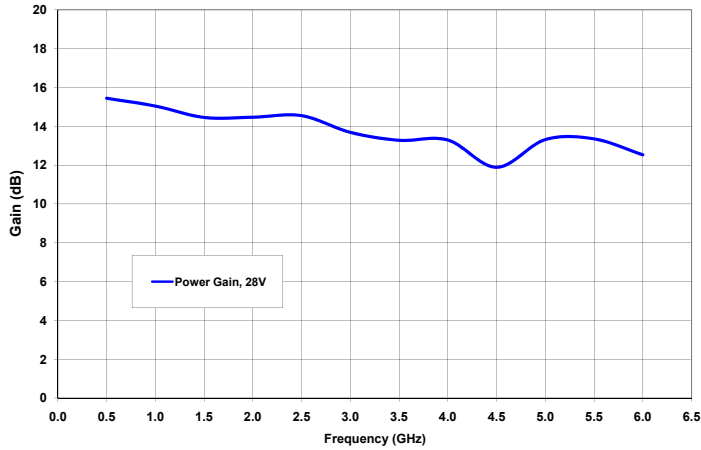

Power Output vs Frequency
 $V_{DD} = 28\text{ V}$, $P_{IN} = 23\text{ dBm}$

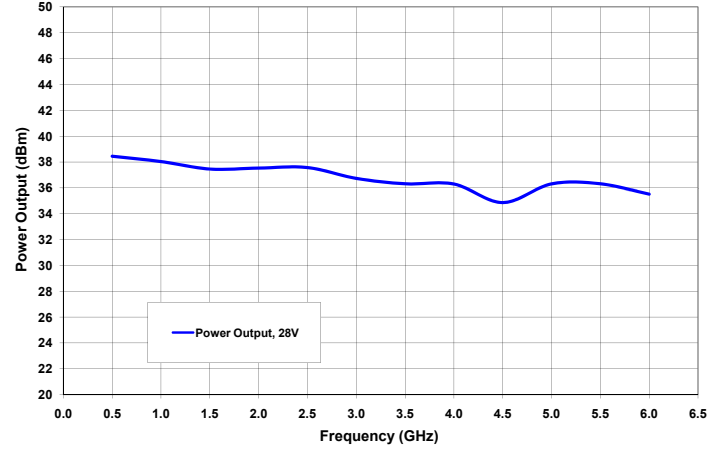

Power Added Efficiency vs Frequency
 $V_{DD} = 28\text{ V}$, $P_{IN} = 23\text{ dBm}$

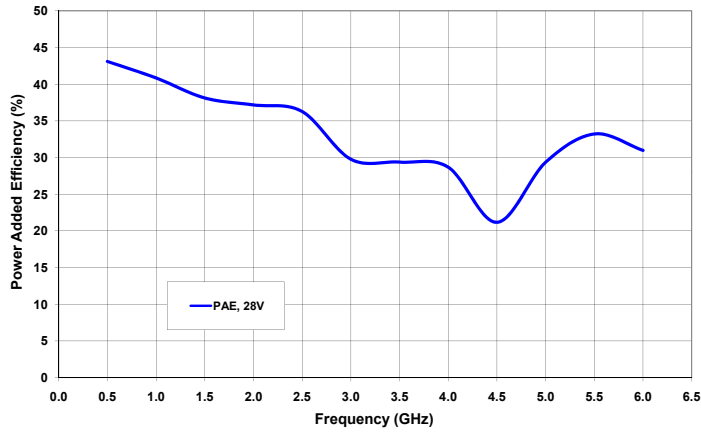

Gain and Return Losses vs Frequency
 $V_{DD} = 28\text{ V}$, $I_{DQ} = 100\text{ mA}$

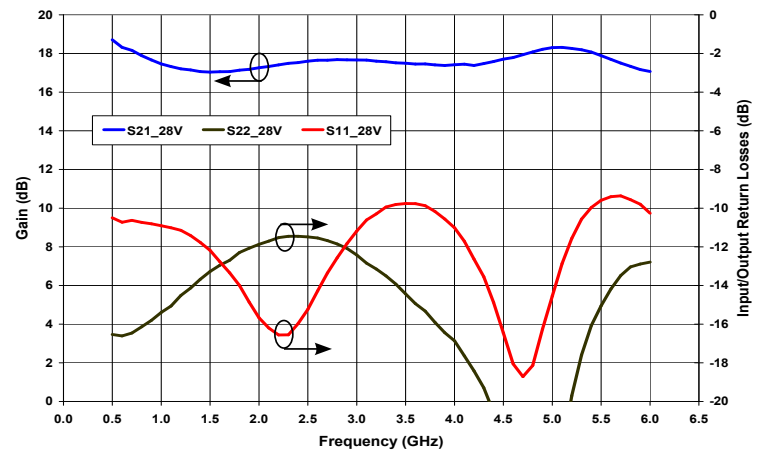



Product Ordering Information

Order Number	Description	Unit of Measure
CMPA0060002D	GaN MMIC Power Amplifier Bare Die	Each



Disclaimer

Specifications are subject to change without notice. Cree, Inc. believes the information contained within this data sheet to be accurate and reliable. However, no responsibility is assumed by Cree for its use or for any infringement of patents or other rights of third parties which may result from its use. No license is granted by implication or otherwise under any patent or patent rights of Cree. Cree makes no warranty, representation or guarantee regarding the suitability of its products for any particular purpose. "Typical" parameters are the average values expected by Cree in large quantities and are provided for information purposes only. These values can and do vary in different applications, and actual performance can vary over time. All operating parameters should be validated by customer's technical experts for each application. Cree products are not designed, intended, or authorized for use as components in applications intended for surgical implant into the body or to support or sustain life, in applications in which the failure of the Cree product could result in personal injury or death, or in applications for the planning, construction, maintenance or direct operation of a nuclear facility. CREE and the CREE logo are registered trademarks of Cree, Inc.

For more information, please contact:

Cree, Inc.
4600 Silicon Drive
Durham, North Carolina, USA 27703
www.cree.com/RF

Sarah Miller
Marketing
Cree, RF Components
1.919.407.5302

Ryan Baker
Marketing & Sales
Cree, RF Components
1.919.407.7816

Tom Dekker
Sales Director
Cree, RF Components
1.919.407.5639