

HSMC-C350

Narrow Angle SMT Red ChipLED

Description

The Broadcom[®] HSMC-C350 is a surface-mount chipLED that comes in an industrial standard footprint of 3.2 mm × 1.6 mm. This chipLED has an integrated optical lens that narrows the viewing angle of the light beam, thereby increasing the on-axis intensity. This allows effective light coupling into secondary optics, such as a light guide and a light pipe.

It offers industry-leading performance by using efficient and high-brightness AlInGaP LED materials.

This chipLED is ideal for applications that require narrow beam angle or high on-axis intensity. Examples include industrial equipment, consumer electronics, and black-and-white home appliances. It is compatible with industry-standard automatic machine placement and reflow soldering.

Features

- LEDs with AlInGaP die
- Narrow viewing angle package with primary lens
- Surface-mount device with industrial-standard footprint
- Compatible with reflow soldering
- Tape in 8-mm carrier tape on a 7-in. diameter reel

Applications

- Push button backlighting
- Icon backlighting
- Status indicator

CAUTION! LEDs are class 1A ESD sensitive per ANSI/ESDA/JEDEC JS-001. Please observe appropriate precautions during handling and processing. Refer to Application Note AN-1142 for additional details.

Figure 1: Package Dimensions

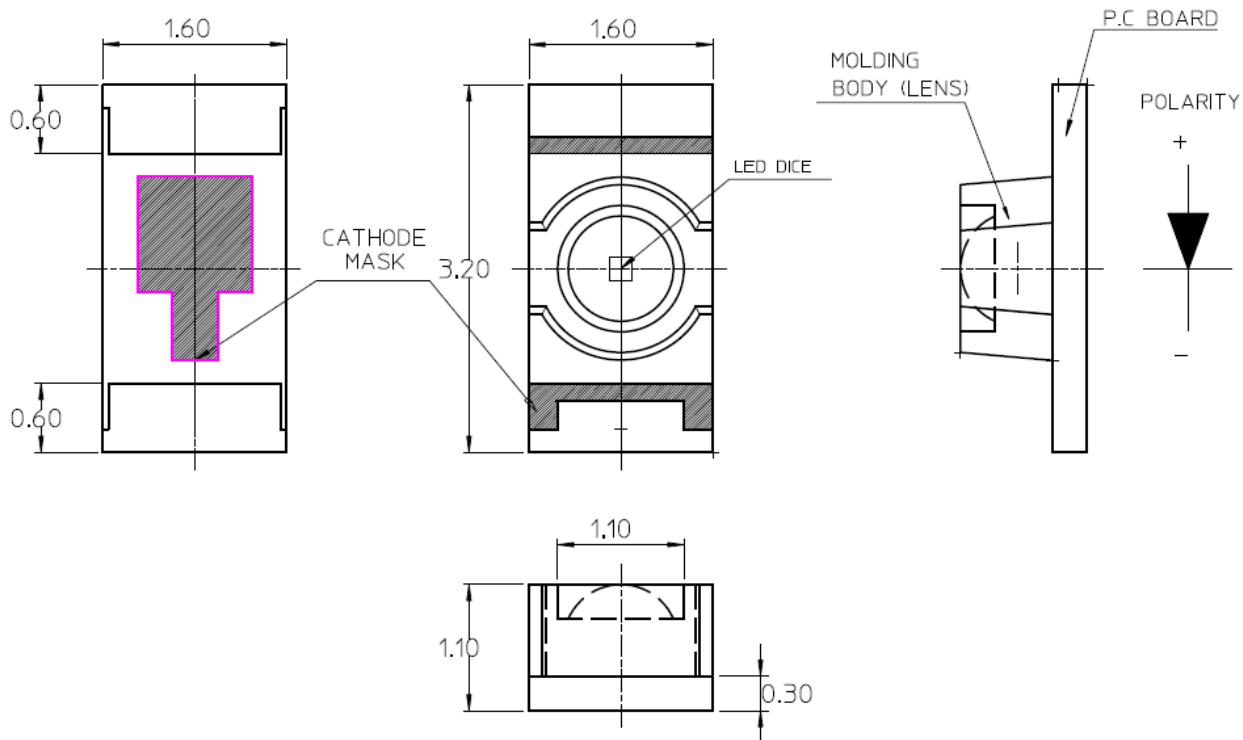
**NOTE:**

1. All dimensions are in millimeters.
2. Tolerance ± 0.1 mm unless otherwise specified.

Absolute Maximum Value at $T_J = 25^\circ\text{C}$

Parameter	Rating	Units
DC Forward Current ^a	25	mA
Peak Forward Current ^b	80	mA
Power Dissipation	60	mW
LED Junction Temperature	95	$^\circ\text{C}$
Operating Temperature Range	-40 to +85	$^\circ\text{C}$
Storage Temperature Range	-40 to +85	$^\circ\text{C}$

a. Derate as shown in [Figure 10](#).

b. Duty factor = 10%, frequency = 1 kHz.

Optical Characteristics at $T_J = 25^\circ\text{C}$, $I_F = 20\text{ mA}$

Parameter	Min.	Typ.	Max.	Units
Luminous Intensity, I_v^a	112.5	—	1125.0	mcd
Dominant Wavelength, λ_d^b	—	630	—	nm
Peak Wavelength, λ_p	—	643	—	nm
Viewing Angle, $2\theta_{1/2}^c$	—	70	—	degree

- a. The luminous intensity is measured at the mechanical axis of the LED package. The actual peak of the spatial radiation pattern may not be aligned with the axis.
- b. The dominant wavelength is derived from the CIE chromaticity diagram and represents the perceived color of the device.
- c. Viewing angle is the off-axis angle where the luminous intensity is $\frac{1}{2}$ the peak intensity.

Electrical Characteristics at $T_J = 25^\circ\text{C}$, $I_F = 20\text{ mA}$

Parameter	Min.	Typ.	Max.	Units
Forward Voltage, V_F	1.6	—	2.4	V
Reverse Current, I_R (at $V_R = 5\text{V}$) ^a	—	—	10	μA
Thermal Resistance, $R\theta_{J-S}$	—	320	—	$^\circ\text{C/W}$

- a. Indicates product final test condition. Long-term reverse bias is not recommended.

Bin Information

Intensity Bins (CAT)

Bin ID	Luminous Intensity (mcd)	
	Min.	Max.
R	112.5	180.0
S	180.0	285.0
T	285.0	450.0
U	450.0	715.0
V	715.0	1125.0

Tolerance $\pm 15\%$.

Color Bin (BIN)

Bin ID	Dominant Wavelength (nm)	
	Min.	Max.
—	620	635

Tolerance $\pm 1\text{ nm}$

Figure 2: Spectrum

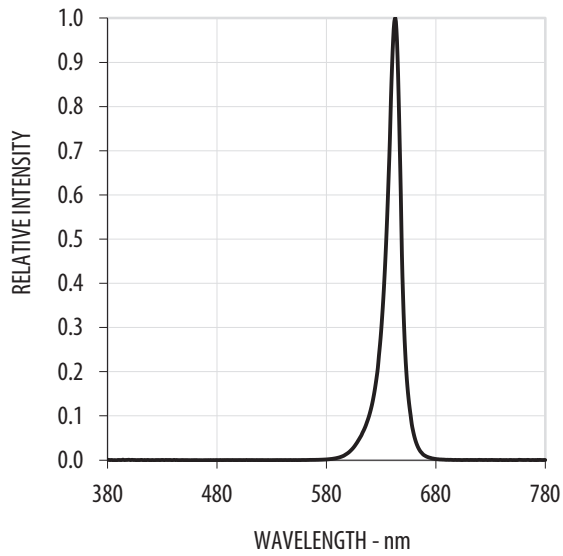

Figure 3: Relative Intensity vs. Forward Current

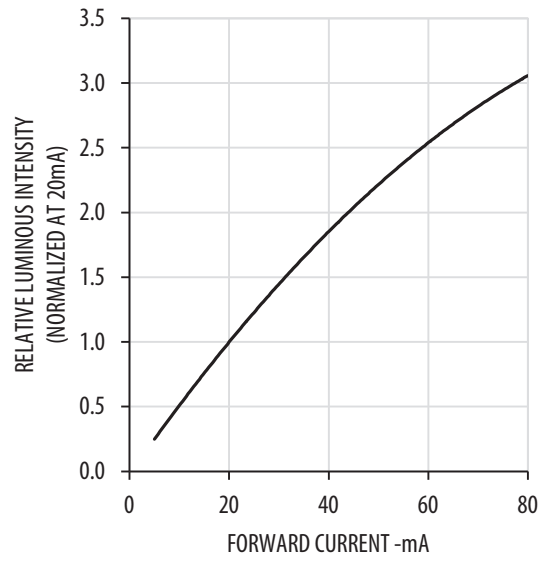

Figure 4: Forward Current vs. Forward Voltage

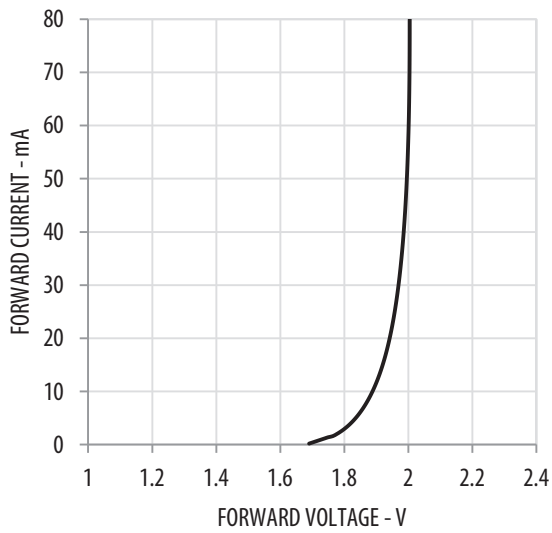

Figure 5: Radiation Pattern

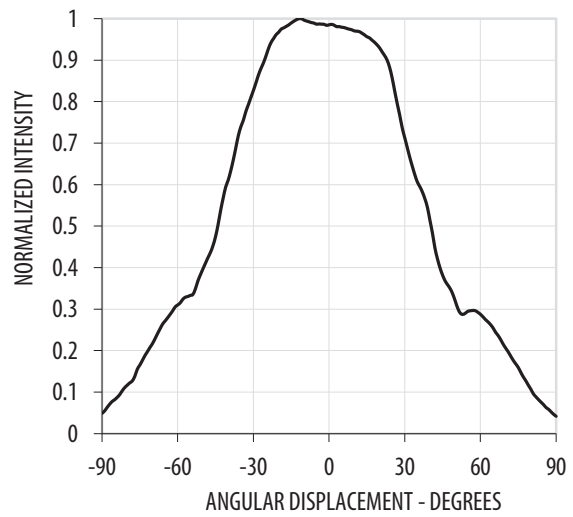

Figure 6: Wavelength Shift vs. Forward Current

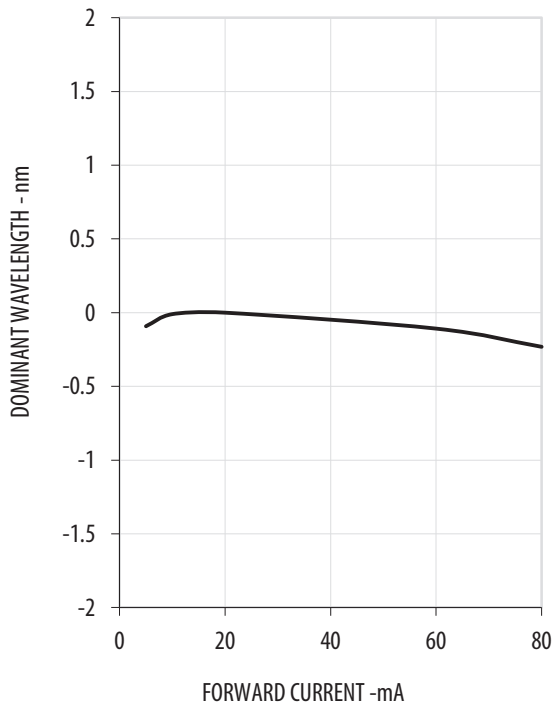

Figure 7: Relative Intensity vs. Temperature

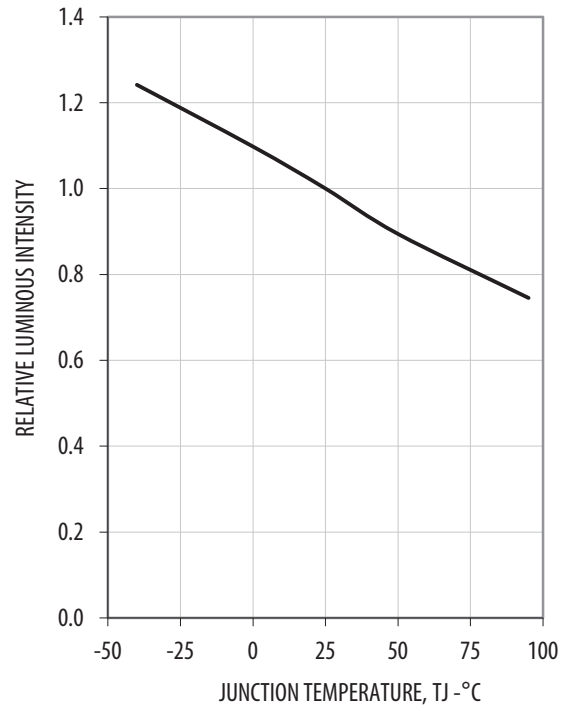

Figure 8: Forward Voltage Shift vs. Temperature

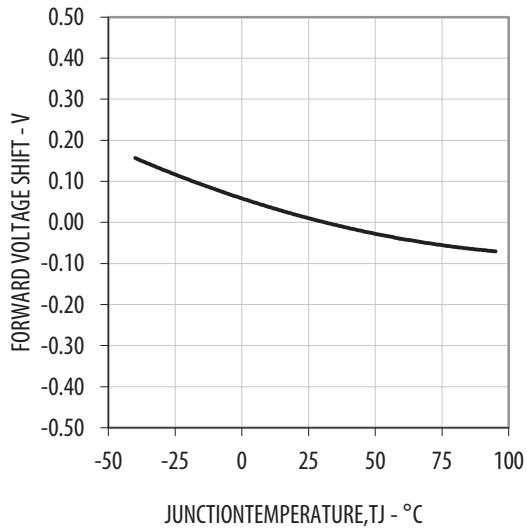

Figure 9: Wavelength Shift vs. Temperature

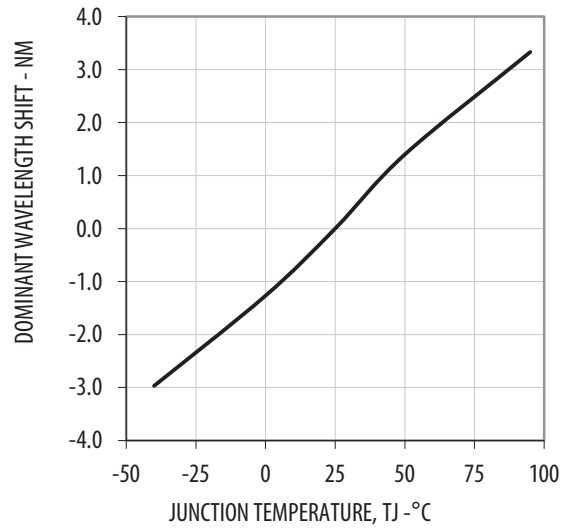

Figure 10: Derating Curve

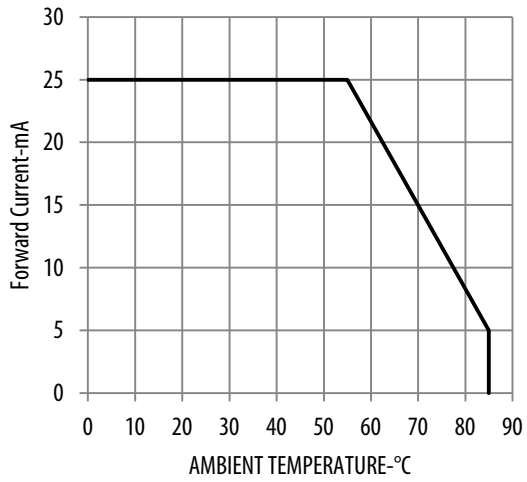

Figure 11: Recommended Solder Pad (Units: mm)

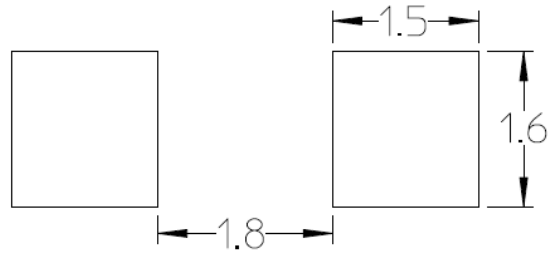

Figure 12: Reel Orientation

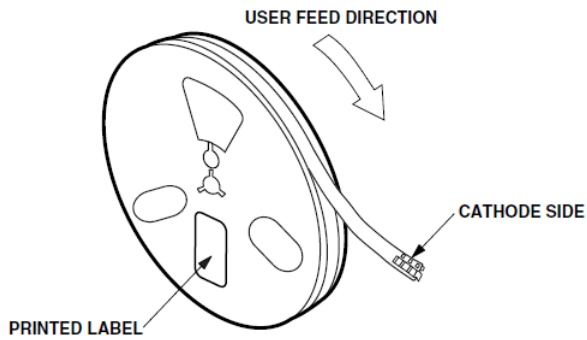
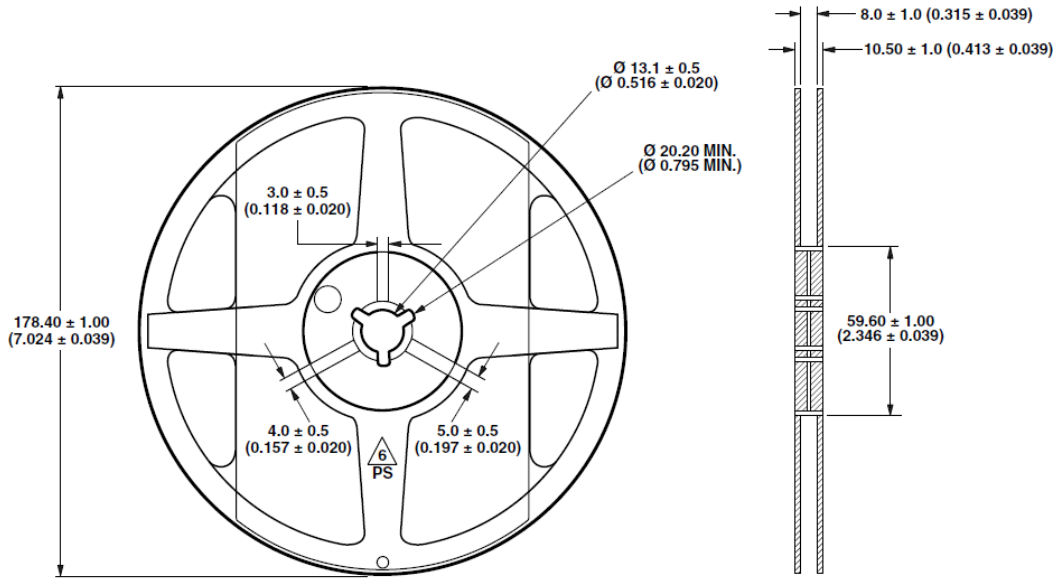
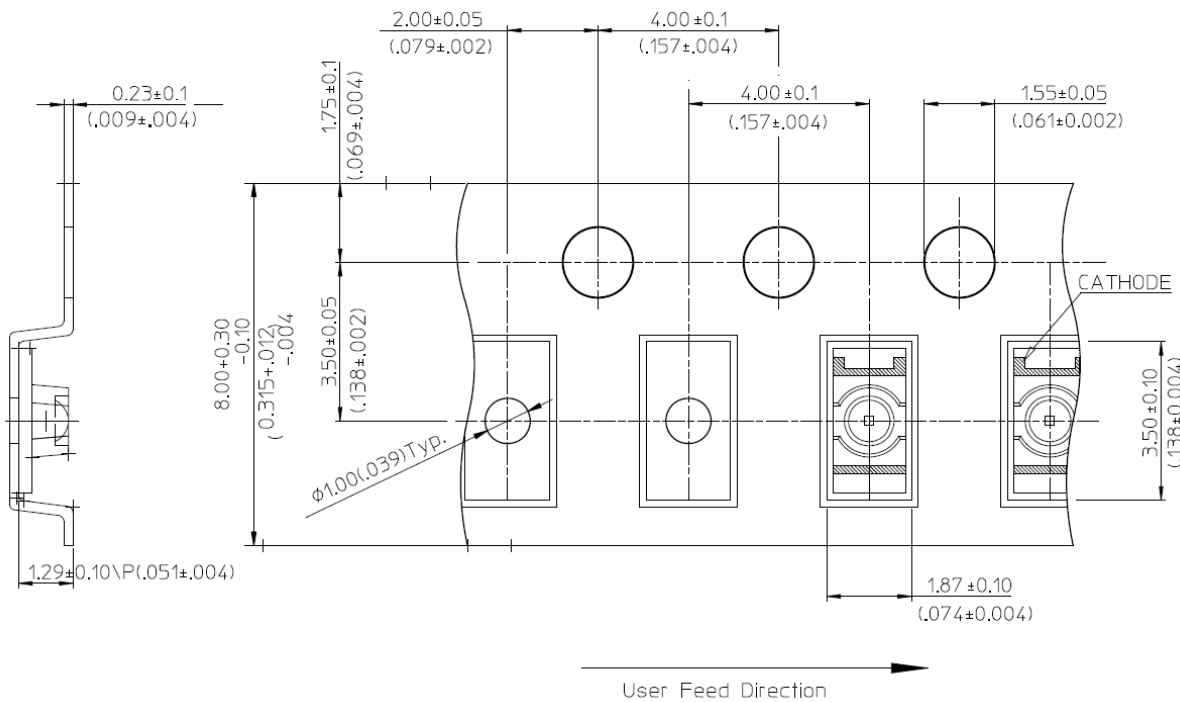

Figure 13: Reel Dimensions (Units: mm)



NOTE:
1. ALL DIMENSIONS IN MILLIMETERS (INCHES).

Figure 14: Carrier Tape Dimensions (Units: mm)



Soldering

Figure 15: Recommended Reflow Soldering Conditions

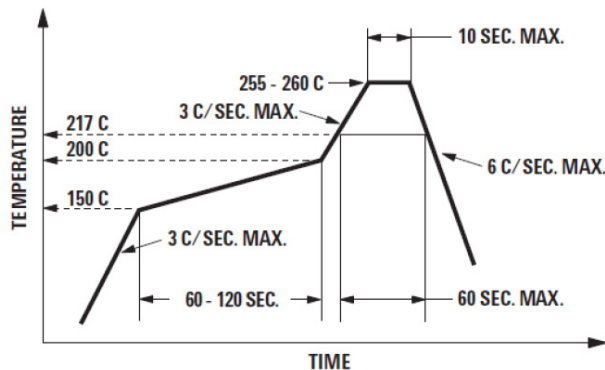

- Reflow soldering must not be done more than twice. Observe necessary precautions of handling moisture sensitive device as stated in the following section.
- Do not apply any pressure or force on the LED during reflow and after reflow when the LED is still hot.
- Use reflow soldering to solder the LED. If unavoidable (such as rework), use manual hand soldering strictly controlled to the following conditions:
 - Soldering iron tip temperature = 310°C maximum
 - Soldering duration = 2 seconds maximum
 - Number of cycles = 1 only
 - Power of soldering iron = 50W maximum
- Do not touch the LED package body with the soldering iron except for the soldering terminals because it might cause damage to the LED.
- Confirm beforehand whether the functionality and performance of the LED is affected by hand soldering.

Precautionary Notes

Handling of a Moisture-Sensitive Device

This product has a Moisture Sensitive Level 2a rating per JEDEC J-STD-020. Refer to Broadcom Application Note AN5305, *Handling of Moisture Sensitive Surface Mount Devices*, for additional details and a review of proper handling procedures.

■ Before use

- An unopened moisture barrier bag (MBB) can be stored at < 40°C/90% RH for 12 months. If the actual shelf life has exceeded 12 months and the humidity indicator card (HIC) indicates that baking is not required, it is safe to reflow the LEDs per the original MSL rating.
- Do not open the MBB prior to assembly (for example, for IQC).

■ Control after opening the MBB

- Read the HIC immediately upon opening the MBB.
- Keep the LEDs at < 30°C/60% RH at all times, and all high-temperature-related processes, including soldering, curing, or rework, must be completed within 672 hours.

■ Control for unfinished reel

Store unused LEDs in a sealed MBB with desiccant or desiccator at < 5% RH.

■ Control of assembled boards

If the PCB soldered with the LEDs is to be subjected to other high-temperature processes, store the PCB in a sealed MBB with desiccant or desiccator at < 5% RH to ensure that all LEDs have not exceeded their floor life of 672 hours.

■ Baking is required if the following conditions exist:

- The HIC indicator is not blue at 10% and is pink at 5%.
- The LEDs are exposed to conditions of > 30°C/60% RH at any time.
- The LEDs' floor life exceeded 672 hours.

The recommended baking condition is: 60°C ±5°C for 20 hours.

Baking should only be done once.

Disclaimer

Broadcom's products are not specifically designed, manufactured, or authorized for sale as parts, components, or assemblies for the planning, construction, maintenance, or direct operation of a nuclear facility or for use in medical devices or applications. The customer is solely responsible, and waives all rights to make claims against Broadcom or its suppliers, for all loss, damage, expense, or liability in connection with such use.

Broadcom, the pulse logo, Connecting everything, Avago Technologies, Avago, and the A logo are among the trademarks of Broadcom and/or its affiliates in the United States, certain other countries and/or the EU.

Copyright © 2015–2017 by Broadcom. All Rights Reserved.

The term “Broadcom” refers to Broadcom Limited and/or its subsidiaries. For more information, please visit www.broadcom.com.

Broadcom reserves the right to make changes without further notice to any products or data herein to improve reliability, function, or design. Information furnished by Broadcom is believed to be accurate and reliable. However, Broadcom does not assume any liability arising out of the application or use of this information, nor the application or use of any product or circuit described herein, neither does it convey any license under its patent rights nor the rights of others.

