



**User Manual**

## **MIO-5250**

**Intel® Atom™ N2600/ D2550,  
3.5" MI/O-Compact SBC, DDR3,  
HDMI, LVDS, VGA, 2 GbE, CFast,  
iManager, MIOe**

**ADVANTECH**

*Enabling an Intelligent Planet*

---

## Copyright

The documentation and the software included with this product are copyrighted 2013 by Advantech Co., Ltd. All rights are reserved. Advantech Co., Ltd. reserves the right to make improvements in the products described in this manual at any time without notice. No part of this manual may be reproduced, copied, translated or transmitted in any form or by any means without the prior written permission of Advantech Co., Ltd. Information provided in this manual is intended to be accurate and reliable. However, Advantech Co., Ltd. assumes no responsibility for its use, nor for any infringements of the rights of third parties, which may result from its use.

## Acknowledgements

Intel® is a trademark of Intel® Corporation.

IBM, PC/AT, PS/2 and VGA are trademarks of International Business Machines Corporation.

Microsoft Windows is a registered trademark of Microsoft Corp.

CHRONTEL is a trademark of Chrontel Inc.

All other product names or trademarks are properties of their respective owners.

## Product Warranty (2 years)

Advantech warrants to you, the original purchaser, that each of its products will be free from defects in materials and workmanship for two years from the date of purchase.

This warranty does not apply to any products which have been repaired or altered by persons other than repair personnel authorized by Advantech, or which have been subject to misuse, abuse, accident or improper installation. Advantech assumes no liability under the terms of this warranty as a consequence of such events.

Because of Advantech's high quality-control standards and rigorous testing, most of our customers never need to use our repair service. If an Advantech product is defective, it will be repaired or replaced at no charge during the warranty period. For out-of-warranty repairs, you will be billed according to the cost of replacement materials, service time and freight. Please consult your dealer for more details.

If you think you have a defective product, follow these steps:

1. Collect all the information about the problem encountered. (For example, CPU speed, Advantech products used, other hardware and software used, etc.) Note anything abnormal and list any onscreen messages you get when the problem occurs.
2. Call your dealer and describe the problem. Please have your manual, product, and any helpful information readily available.
3. If your product is diagnosed as defective, obtain an RMA (return merchandise authorization) number from your dealer. This allows us to process your return more quickly.
4. Carefully pack the defective product, a fully-completed Repair and Replacement Order Card and a photocopy proof of purchase date (such as your sales receipt) in a shippable container. A product returned without proof of the purchase date is not eligible for warranty service.
5. Write the RMA number visibly on the outside of the package and ship it prepaid to your dealer.

## Declaration of Conformity

### CE

This product has passed the CE test for environmental specifications. Test conditions for passing included the equipment being operated within an industrial enclosure. In order to protect the product from being damaged by ESD (Electrostatic Discharge) and EMI leakage, we strongly recommend the use of CE-compliant industrial enclosure products.

### FCC Class A

This equipment has been tested and found to comply with the limits for a Class A digital device, pursuant to part 15 of the FCC Rules. These limits are designed to provide reasonable protection against harmful interference when the equipment is operated in a commercial environment. This equipment generates, uses, and can radiate radio frequency energy and, if not installed and used in accordance with the instruction manual, may cause harmful interference to radio communications. Operation of this equipment in a residential area is likely to cause harmful interference in which case the user will be required to correct the interference at his own expense.

---

## Technical Support and Assistance

1. Visit the Advantech web site at [www.advantech.com](http://www.advantech.com) where you can find the latest information about the product.
2. Contact your distributor, sales representative, or Advantech's customer service center for technical support if you need additional assistance. Please have the following information ready before you call:
  - Product name and serial number
  - Description of your peripheral attachments
  - Description of your software (operating system, version, application software, etc.)
  - A complete description of the problem
  - The exact wording of any error messages

## Warnings, Cautions and Notes

**Warning!** *Warnings indicate conditions, which if not observed, can cause personal injury!*



**Caution!** *Cautions are included to help you avoid damaging hardware or losing data. e.g.*



*There is a danger of a new battery exploding if it is incorrectly installed. Do not attempt to recharge, force open, or heat the battery. Replace the battery only with the same or equivalent type recommended by the manufacturer. Discard used batteries according to the manufacturer's instructions.*

**Note!** *Notes provide optional additional information.*



## Document Feedback

To assist us in making improvements to this manual, we would welcome comments and constructive criticism. Please send all such - in writing to: [support@advantech.com](mailto:support@advantech.com)

## Packing List

Before setting up the system, check that the items listed below are included and in good condition. If any item does not accord with the table, please contact your dealer immediately.

- 1 x MIO-5250 SBC
- 1 x SATA Cable 32cm (P/N 1700008941)
- 1 x SATA Power Cable 35cm (P/N 1700018785)
- 1 x Audio Cable 20cm (P/N 1700019584)
- 2 x COM RS-232 Cable 22cm (P/N 1701200220)
- 2 x COM RS-422/485 Cable 25cm (P/N 1700019435)
- 1 x Heatsink (20mm) (P/N 1960054272T001)
- Startup Manual
- CD-ROM (User manual and drivers)
- 1 x Mini Jumper(10pcs package) (P/N 9689000002)

## Ordering Information

MIO-5250N-S6A1E Intel® Atom™ N2600 Dual Core + NM10  
 MIO-5250D-S8A1E Intel® Atom™ D2550 Dual Core + NM10

	<b>MIO-5250N-S6A1E</b>	<b>MIO-5250D-S8A1E</b>
CPU	Intel® Atom™ N2600 1.6G Dual Core	Intel® Atom™ D2550 1.86G Dual Core
L2 Cache	1 MB L2	1 MB L2
LVDS	24 bit LVDS1	24 bit LVDS1 48 bit LVDS2
VGA	Yes	Yes
HDMI	Yes	Yes
GbE	2	2
Audio	Yes	Yes
RS-232/422/485	2	2
RS-232	2	2
USB 2.0	6	6
GPIO	8-bit	8-bit
SATAII	1	1
CFast	1	1
Full-size Mini PCIe	1	1
MIOe	Yes	Yes
Thermal Solution	Fanless	Fanless
Operational Temp.	0 ~ 60° C	0 ~ 60° C

## Optional MIOe Module

Part Number	Description
MIOe-210-D6A1E	4x RS232/422/485 2x RS422/485 with DSUB connector, 8-bit GPIO
MIOe-220-B3A1E	3 x GbE with RJ45 connector through PCIe switch
MIOe-230-L0A1E*	Displayport to 48-bit LVDS
MIOe-DB5000-01A1E*	MI/O extension evaluation board w/ PCIe switch

\*MIOe-230 compatibility is optional by request (need BOM update).

## Optional Accessories

Part number	Description
1960054269T001	Heat spreader 137x84.2x16.7-mm MIO-5250
1703100260	Internal USB 5/6 cable
1935032000	Screw of Heatsink / Cooler R/S 5.5 2.0 +M M3*20L ST Ni
1930000058	The POST Stand off, F=M3*8L M=M3*4L D=5 H=19L Cu
1757003934	ADAPTER 100-240V 60W 12V 5A W/O PFC

## Safety Instructions

1. Read these safety instructions carefully.
2. Keep this User Manual for later reference.
3. Disconnect this equipment from any AC outlet before cleaning. Use a damp cloth. Do not use liquid or spray detergents for cleaning.
4. For plug-in equipment, the power outlet socket must be located near the equipment and must be easily accessible.
5. Keep this equipment away from humidity.
6. Put this equipment on a reliable surface during installation. Dropping it or letting it fall may cause damage.
7. The openings on the enclosure are for air convection. Protect the equipment from overheating. DO NOT COVER THE OPENINGS.
8. Make sure the voltage of the power source is correct before connecting the equipment to the power outlet.
9. Position the power cord so that people cannot step on it. Do not place anything over the power cord.
10. All cautions and warnings on the equipment should be noted.
11. If the equipment is not used for a long time, disconnect it from the power source to avoid damage by transient overvoltage.
12. Never pour any liquid into an opening. This may cause fire or electrical shock.
13. Never open the equipment. For safety reasons, the equipment should be opened only by qualified service personnel.

14. If one of the following situations arises, get the equipment checked by service personnel:
  - The power cord or plug is damaged.
  - Liquid has penetrated into the equipment.
  - The equipment has been exposed to moisture.
  - The equipment does not work well, or you cannot get it to work according to the user's manual.
  - The equipment has been dropped and damaged.
  - The equipment has obvious signs of breakage.
15. DO NOT LEAVE THIS EQUIPMENT IN AN ENVIRONMENT WHERE THE STORAGE TEMPERATURE MAY GO BELOW -20° C (-4° F) OR ABOVE 60° C (140° F). THIS COULD DAMAGE THE EQUIPMENT. THE EQUIPMENT SHOULD BE IN A CONTROLLED ENVIRONMENT.
16. CAUTION: DANGER OF EXPLOSION IF BATTERY IS INCORRECTLY REPLACED. REPLACE ONLY WITH THE SAME OR EQUIVALENT TYPE RECOMMENDED BY THE MANUFACTURER, DISCARD USED BATTERIES ACCORDING TO THE MANUFACTURER'S INSTRUCTIONS.

The sound pressure level at the operator's position according to IEC 704-1:1982 is no more than 70 dB (A).

DISCLAIMER: This set of instructions is given according to IEC 704-1. Advantech disclaims all responsibility for the accuracy of any statements contained herein.

## Safety Precaution - Static Electricity

Follow these simple precautions to protect yourself from harm and the products from damage.

- To avoid electrical shock, always disconnect the power from your PC chassis before you work on it. Don't touch any components on the CPU card or other cards while the PC is on.
- Disconnect power before making any configuration changes. The sudden rush of power as you connect a jumper or install a card may damage sensitive electronic components.





# Contents

<b>Chapter 1</b>	<b>General Information .....</b>	<b>1</b>
1.1	Introduction .....	2
1.2	Specifications .....	2
1.2.1	General Specification .....	2
1.2.2	Functional Specifications .....	3
1.2.3	Mechanical Specifications .....	4
1.2.4	Electrical Specifications .....	5
1.2.5	Environmental Specifications .....	5
1.3	Block Diagram .....	6
	Figure 1.1 Block Diagram .....	6
<b>Chapter 2</b>	<b>Hardware Installation .....</b>	<b>7</b>
2.1	Jumpers .....	8
2.1.1	Jumper List .....	8
	Table 2.1: Jumpers .....	8
2.1.2	Jumper Settings .....	8
2.1.3	Jumper Description .....	10
2.2	Connectors .....	11
2.2.1	Connector List .....	11
	Table 2.2: Connectors .....	11
2.3	Mechanical .....	12
2.3.1	Jumper and Connector Location .....	12
	Figure 2.1 Jumper and Connector Layout (Top Side) .....	12
	Figure 2.2 Jumper and Connector Layout (Bottom Side) .....	12
2.3.2	Board Dimensions .....	13
	Figure 2.3 Board Dimensions (Component Side) .....	13
	Figure 2.4 Board Dimensions (Solder Side) .....	13
	Figure 2.5 I/O Connectors Mechanical Drawing .....	14
<b>Chapter 3</b>	<b>BIOS Settings .....</b>	<b>15</b>
3.1	BIOS Setup .....	16
	Figure 3.1 Setup program initial screen .....	16
3.2	Entering Setup .....	16
3.3	Main Setup .....	17
	Figure 3.2 Main setup screen .....	17
3.3.1	System date / System time .....	17
3.4	Advanced BIOS Features Setup .....	18
	Figure 3.3 Advanced BIOS features setup screen .....	18
3.4.1	Advantech BIOS Update V1.3 .....	18
3.4.2	ACPI Settings .....	19
	Figure 3.4 ACPI Setting .....	19
3.4.3	TPM Configuration .....	20
	Figure 3.5 TPM Configuration .....	20
3.4.4	CPU Configuration .....	20
	Figure 3.6 CPU Configuration .....	20
3.4.5	SATA Configuration .....	21
	Figure 3.7 SATA Configuration .....	21
3.4.6	Intel Fast Flash Standby .....	22
	Figure 3.8 Intel Fast Flash Standby .....	22
3.4.7	USB Configuration .....	22
	Figure 3.9 USB Configuration .....	22

3.4.8	Embedded Controller Configuration .....	23
	Figure 3.10 Embedded Controller Configuration .....	23
3.4.9	Super I/O Configuration .....	24
	Figure 3.11 Super IO Configuration .....	24
3.4.10	AOAC Configuration .....	25
	Figure 3.12 AOAC Configuration .....	25
3.4.11	PPM Configuration .....	25
	Figure 3.13 PPM Configuration .....	25
3.5	Chipset Configuration .....	26
	Figure 3.14 Chipset Setup .....	26
3.5.1	Host Bridge/Intel IGD Configuration .....	27
	Figure 3.15 Intel IGD Configuration .....	27
3.5.2	South Bridge .....	28
	Figure 3.16 South Bridge .....	28
	Figure 3.17 TPT Device .....	29
3.6	Boot Settings .....	30
	Figure 3.18 Boot Setup Utility .....	30
3.7	Security Setup .....	31
	Figure 3.19 Password Configuration .....	31
3.8	Save & Exit .....	32
	Figure 3.20 Save & Exit .....	32
3.8.1	Save Changes and Exit .....	32
3.8.2	Discard Changes and Exit .....	32
3.8.3	Save Changes and Reset .....	32
3.8.4	Discard Changes and Reset .....	32
3.8.5	Save Changes .....	32
3.8.6	Discard Changes .....	33
3.8.7	Restore Defaults .....	33
3.8.8	Save User Defaults .....	33
3.8.9	Restore User Defaults .....	33
3.8.10	Boot Override .....	33

## **Chapter 4 MIOe Installation ..... 35**

## **Appendix A Pin Assignments ..... 37**

## **Appendix B System Assignments ..... 59**

B.1	System I/O Ports .....	60
	Table B.1: System I/O Ports .....	60
B.2	DMA Channel assignments .....	60
	Table B.2: DMA Channel assignments .....	60
B.3	1st MB memory map .....	61
	Table B.3: 1st MB memory map .....	61
B.4	Interrupt assignments .....	61
	Table B.4: Interrupt assignments .....	61

## **Appendix C Watchdog Timer Sample Code ..... 63**

C.1	EC Watchdog Timer sample code .....	64
-----	-------------------------------------	----

# Chapter 1

General Information

## 1.1 Introduction

Advantech created the stackable architecture MI/O Extension Single Board Computer as a SBC design with flexible and multiple I/O support (hence the name MI/O) and united extended interface connector. MIO-5250 is a MI/O-Compact SBC (Single Board Computer) with Intel® Atom™ Cedar Trail ultra low power solution supporting up to 4GB 800/1066MHz DDR3, 6 USB2.0, SATAII (300 MBs), 4 COM and 2 GbE (up to 1000 Mbps). MIO-5250 supports dual displays, including VGA+LVDS, VGA+HDMI, and HDMI+LVDS. Also have flexible storage option, including mSATA and CFast. In addition, MIO-5250 supports DisplayPort, PCIe x1, USB2.0, LPC, SMBus, HD audio line out and Power from MIOe. Users can choose from a standard module or design their own modules to secure domain knowledge and expedite their design schedule.

## 1.2 Specifications

### 1.2.1 General Specification

CPU	CPU: Intel® Atom - N2600 (Dual Core 1.6GHz) on MIO-5250N-S6A1E - D2550 (Dual Core 1.86GHz) on MIO-5250D-S8A1E
L2 Cache	N2600: 1MB D2550: 1MB
System Chipset	Intel® Atom N2600 / D2550 + NM10
BIOS	AMI EFI 16-Mbit
System Memory	1 x 204-pin SODIMM socket DDR3 up to 4GB: N2600: up to DDR3 800 MHz D2550: up to DDR3 1066 MHz
Power Management	APM1.2, ACPI support
Watchdog Timer	255 levels timer interval, programmable by software. Multi level WDT (set by iManager)
Expansion Interface	Full-size Mini PCIe with SIM Holder (supports mSATA via BIOS select), CFast, MIOe
Battery	Lithium 3 V / 210 mAH

### I/O

Internal I/O Interface	1 x SATAII, 2 x RS-232, 2 x RS232/422/485, 2 x USB 2.0, GPIO, SMBus, HD Audio
Rear I/O	4 x USB 2.0, HDMI, VGA, 2 x RJ45 Ethernet, Power connector
Power Connector Type	MIO-5250N-S6A1E: DC Jack MIO-5250D-S8A1E: 2 x 2 pin Power connector
SMBus	Supported
I <sup>2</sup> C	Supported (Shares with SMBus pin)
GPIO	8-bit general purpose input/output

### Ethernet

Speed	GbE 10/100/1000 Mbps
Chipset	Intel® 82583V (GbE1, GbE2)
Ethernet Interface	Fully compliant with IEEE 802.3, IEEE 802.3u, IEEE 802.3ab

Connector	RJ45 x2
Wake On Function	Wake-on-LAN
<b>Display</b>	
Controller	Intel® Atom N2600 / D2550
Resolution	<ul style="list-style-type: none"> <li>■ VGA: N2600 / D2550: 1920 x 1200</li> <li>■ LVDS: <ul style="list-style-type: none"> <li>N2600: 24-bit LVDS1, resolution up to 1366 x 768</li> <li>D2550: 24-bit LVDS1, resolution up to 1440 x 900,</li> <li>48-bit LVDS2 (JEIDA support), resolution up to 2560 x 1600</li> </ul> </li> <li>(LVDS1 or LVDS2 both need select "Built-in Display" in OS)</li> <li>■ HDMI: <ul style="list-style-type: none"> <li>Supports 1920 x 1200p @60Hz, 36bpp</li> <li>Supports HDMI 1.3, Max data rate up to 1.65Gb/s</li> </ul> </li> </ul>
Dual Independent Display	VGA+LVDS, VGA+HDMI, HDMI+LVDS

## 1.2.2 Functional Specifications

### Processor: Intel® Atom N2600/D2550

CPU Process	32nm
Frequency	<ul style="list-style-type: none"> <li>- N2600: 1.6GHz</li> <li>- D2550: 1.86GHz</li> </ul>
VGA Memory	Up to 512MB of dynamic video memory allocation
Internal Graphics Features	<ul style="list-style-type: none"> <li>■ DirectX® 9 and OpenGL 3.0</li> <li>■ Display Port 1.1, HDMI 1.3a</li> <li>■ Supports HDCP 1.3</li> <li>■ Intel® Display Power saving technology 6.0</li> <li>■ SGXS45 Power VR Core 400/640 MHz</li> </ul>
Video Accelerator	<ul style="list-style-type: none"> <li>■ H/W accelerated video decode</li> <li>■ Video decoder: Support MPEG4, VC1, WMV9, H.264</li> <li>■ Supports DVD, Blu-ray, and HD video</li> </ul>

### 1.2.2.1 Chipset (NM10)

<b>South Bridge</b>	
Control Hub	NM10
RS-232	2
RS-232/422/485	2
K/B	1
Mouse	1
USB	6 x USB 2.0
Audio	HD Audio, ALC892 Codec, Line-in, Line-out, Mic-in, speaker out (R/L) (Supports 8Ω 1W or 4Ω 2 W Speaker for Speaker-out)
Other Features	<ul style="list-style-type: none"> <li>* 6 x USB 2.0 ports, 480MB/s (all internal connectors) Default: 500mA @ one port (Up to 1A @ 2 ports)</li> <li>* 1 x SATAII (Max. Data transfer Rate 300MB/s)</li> <li>* HD Audio CODEC (ALC892)</li> <li>* Power Management (S0, S3,S4, S5)</li> </ul>
BIOS	16-Mbit Flash BIOS via SPI

### 1.2.2.2 iManager

<b>iManager</b>	
Sequence control	Supported
SMBus	Supported
GPIO	8-bit GPIO
Watchdog timer	Multi Level WDT (set by Advantech iManager) Programmable 1-255 sec / min
Hardware monitor	Input Voltage
Power saving	Deep sleep S5 mode/Back light control
Board information	Running HR / Boot record
Storage	Read / Write data protection
VGA	Low Level Backlight / Brightness control

### 1.2.2.3 Others

<b>Gigabit Ethernet</b>	
Chipset	Intel® 82583V (GbE1, GbE2)
IEEE Compliant	Fully compliant with IEEE 802.3, IEEE 802.3u, IEEE 802.3ab
Disable LAN through BIOS	Yes
Driver Support	WES7
<b>High Definition Audio</b>	
Codec	Realtek ALC892
Connector	Line in, Line out, Mic in
Voltage	+3.3V, +5V, +12V, Vcore

## 1.2.3 Mechanical Specifications

### 1.2.3.1 Dimensions (mm)

146 x 102 mm (5.7 x 4 inches)

### 1.2.3.2 Board height on Top side (mm)

16.4mm (Rear I/O USB)

### 1.2.3.3 Board height on bottom side (mm)

9mm (Full-size Mini PCIe socket)

### 1.2.3.4 Heatsink/Cooler Dimensions (mm)

137mm (L) x 87.2mm (W) x 25mm (H)

### 1.2.3.5 Board net weight without heatsink (g)

140 g

## 1.2.4 Electrical Specifications

### 1.2.4.1 Power Supply Voltage

- **Power Type**  
Single 12V DC power in
- **Power Supply Voltage**  
Single 12V  $\pm$  10%

### 1.2.4.2 Power Consumption

Test Condition:

- Add-in Card - None
- Full-size Mini PCIe - None
- Memory - DDR3 SODIMM 2GB
- HDD - 3.5" WD 80GB SATA2 \*1
- KeyBoard/Mouse - USB
- Display - VGA

Condition	Power Consumption (A)			
	Voltage/ Condition	DOS Idle Mode	Win. Idle Mode	Win. HCT12 (10minutes)
MIO-5250N-S6A1E	+12V	0.606	0.524	0.729
MIO-5250D-S8A1E	+12V	0.829	0.739	1.029

### 1.2.4.3 RTC Battery

- **Typical Voltage:** 3.0 V
- **Normal discharge capacity:** 210 mAh

## 1.2.5 Environmental Specifications

### 1.2.5.1 Operating Temperature

- **Operating temperature:** 0 ~ 60°C (32~140°F)

### 1.2.5.2 Operating Humidity

- **Operating Humidity:** 0% ~ 90% Relative Humidity, non-condensing

### 1.2.5.3 Storage Temperature

Standard products (0~60°C)

- **Storage temperature:** -40~85°C

### 1.2.5.4 Storage Relative Temperature

Standard products (0~60°C)

- **Relative humidity:** 95% @ 60°C

Phoenix products (-20~80°C)

- **Relative humidity:** 95% @ 60°C

Platinum Phoenix products (-40~85°C)

- **Relative humidity:** 95% @ 60°C

# 1.3 Block Diagram

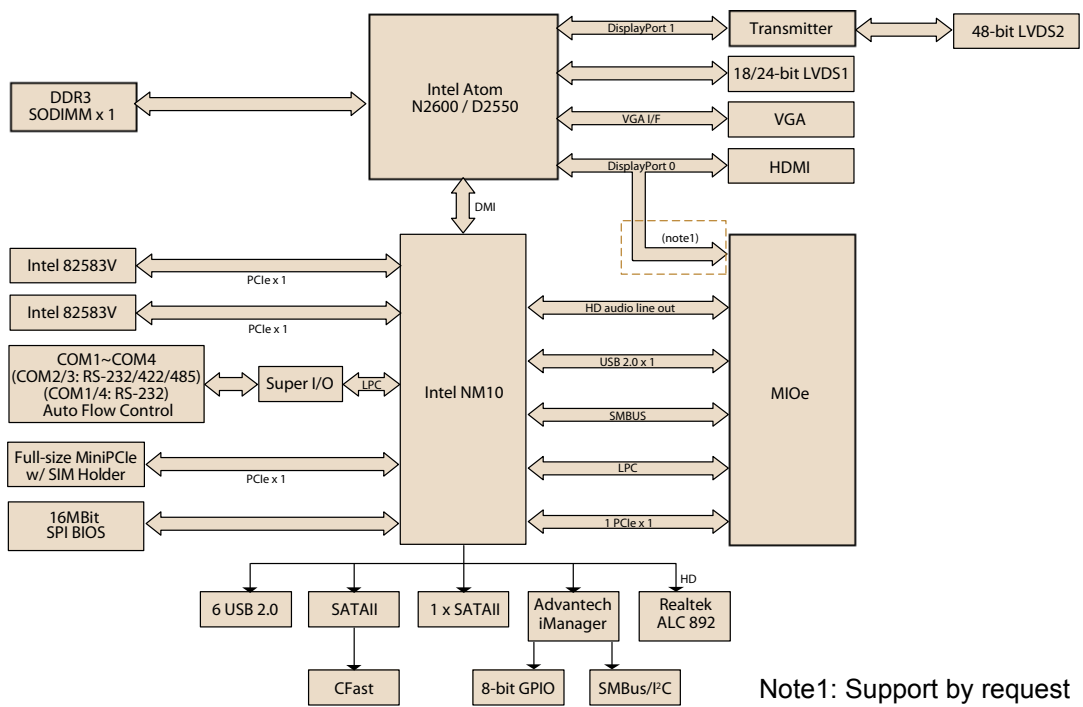

**Figure 1.1 Block Diagram**

Note1: Support by request



# Chapter 2

## Hardware Installation

This chapter explains the setup procedures of the MIO-5250 A1 hardware, including instructions on setting jumpers and connecting peripherals, switches, indicators and mechanical drawings. Be sure to read all safety precautions before you begin the installation procedure.

## 2.1 Jumpers

### 2.1.1 Jumper List

**Table 2.1: Jumpers**

Label	Function
J1	24-bit LVDS1 Power
J2	48-bit LVDS2 Power
J3	Auto Power on setting
J4	COM2 Setting
J5	COM3 setting
J6	Clear CMOS

### 2.1.2 Jumper Settings

J1	24 bits LVDS1 Power
<b>Part Number</b>	1653003260
<b>Footprint</b>	HD_3x2P_79
<b>Description</b>	PIN HEADER 3x2P 2.0mm 180D(M) SMD 21N22050
<b>Setting</b>	<b>Function</b>
(1-3)*	+3.3V (default)
(3-5)	+5V
(3-4)	+12V

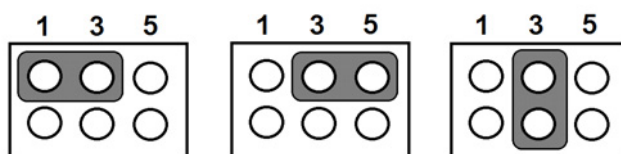

J2	48 bits LVDS2 Power
<b>Part Number</b>	1653003260
<b>Footprint</b>	HD_3x2P_79
<b>Description</b>	PIN HEADER 3x2P 2.0mm 180D(M) SMD 21N22050
<b>Setting</b>	<b>Function</b>
(1-3)*	+3.3V (default)
(3-5)	+5V
(3-4)	+12V

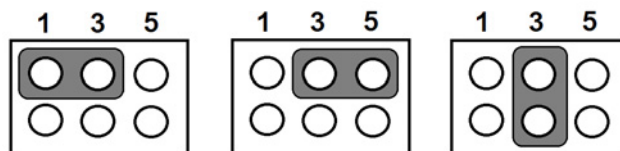

<b>J3</b>	<b>Auto Power On Setting</b>
<b>Part Number</b>	1653002101
<b>Footprint</b>	HD_2x1P_79_D
<b>Description</b>	PIN HEADER 2*1P 180D(M)SQUARE 2.0mm DIP W/O Pb
<b>Setting</b>	Function
NC	Power Button for Power On
(1-2)*	Auto Power On (default)



<b>J4</b>	<b>COM2 Setting</b>
<b>Part Number</b>	1653003260
<b>Footprint</b>	HD_3x2P_79
<b>Description</b>	PIN HEADER 3x2P 2.0mm 180D(M) SMD 21N22050
<b>Setting</b>	Function
(1-2)*	RS232 (default)
(3-4)	RS485
(5-6)	RS422

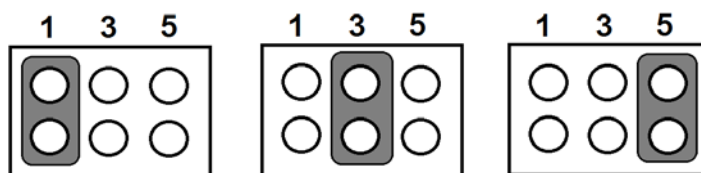

<b>J5</b>	<b>COM3 Setting</b>
<b>Part Number</b>	1653003260
<b>Footprint</b>	HD_3x2P_79
<b>Description</b>	PIN HEADER 3x2P 2.0mm 180D(M) SMD 21N22050
<b>Setting</b>	Function
(1-2)*	RS232 (default)
(3-4)	RS485

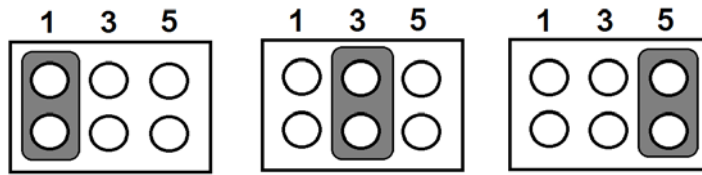

<b>J6</b>	<b>Clear CMOS</b>
<b>Part Number</b>	1653003101
<b>Footprint</b>	HD_3x1P_79_D
<b>Description</b>	PIN HEADER 3x1P 2.0mm 180D(M) DIP 2000-13 WS
<b>Setting</b>	<b>Function</b>
(1-2)*	Normal (default)
(2-3)	Clear COMS

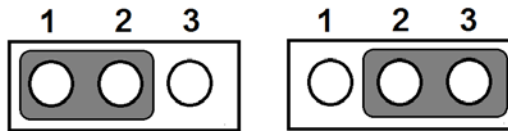

### 2.1.3 Jumper Description

Cards can be configured by setting jumpers. A jumper is a metal bridge used to close an electric circuit. It consists of two metal pins and a small metal clip (often protected by a plastic cover) that slides over the pins to connect them. To close a jumper, you connect the pins with the clip. To open a jumper, you remove the clip. Sometimes a jumper will have three pins, labeled 1, 2 and 3. In this case you would connect either pins 1 and 2, or 2 and 3.

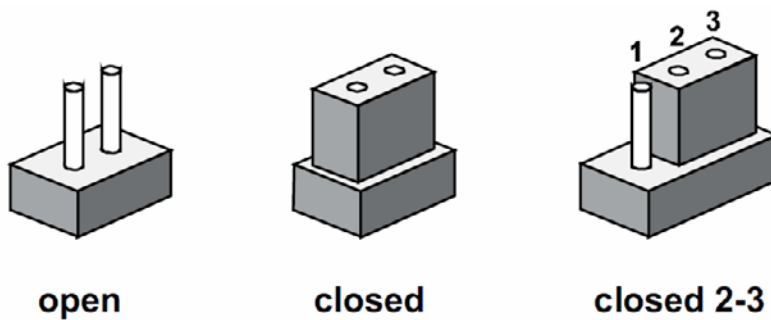

The jumper settings are schematically depicted in this manual as follows.

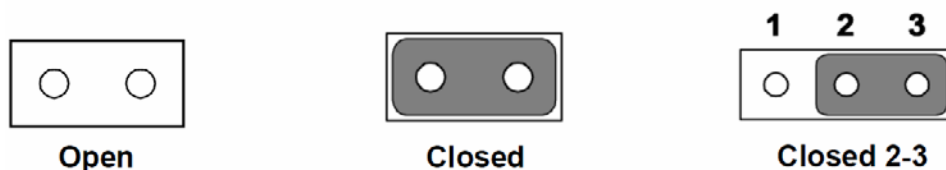

A pair of needle-nose pliers may be helpful when working with jumpers. If you have any doubts about the best hardware configuration for your application, contact your local distributor or sales representative before you make any changes.

**Warning!** *To avoid damaging the computer, always turn off the power supply before setting jumpers to clear CMOS. Before turning on the power supply, set the jumper back to 3.0 V Battery On.*



## 2.2 Connectors

### 2.2.1 Connector List

**Table 2.2: Connectors**

Label	Function
CN1	12V Power Input
CN2	DC JACK
CN3	DDR3 SO-DIMM
CN5	Power Switch
CN7	Reset
CN9	GPIO
CN10	VGA
CN11	CFast
CN12	SIM Holder
CN13	Full-size Mini PCIe
CN14	SATA
CN15	SATA Power
CN16	USB 3/4
CN17	Internal USB
CN18	USB 1/2
CN19	COM1/COM2 RS-232
CN20	RS422/485 1
CN22	RS422/485 2
CN24	COM3/COM4 RS-232
CN25	SMBus
CN26	System FAN
CN28	LAN
CN30	Audio
CN31	MIOe
CN33	24 bits LVDS1 Panel
CN34	48 bits LVDS2 Inverter Power
CN35	48 bits LVDS2 Panel
CN36	HDMI
CN38	LVDS1 Inverter Power

## 2.3 Mechanical

### 2.3.1 Jumper and Connector Location

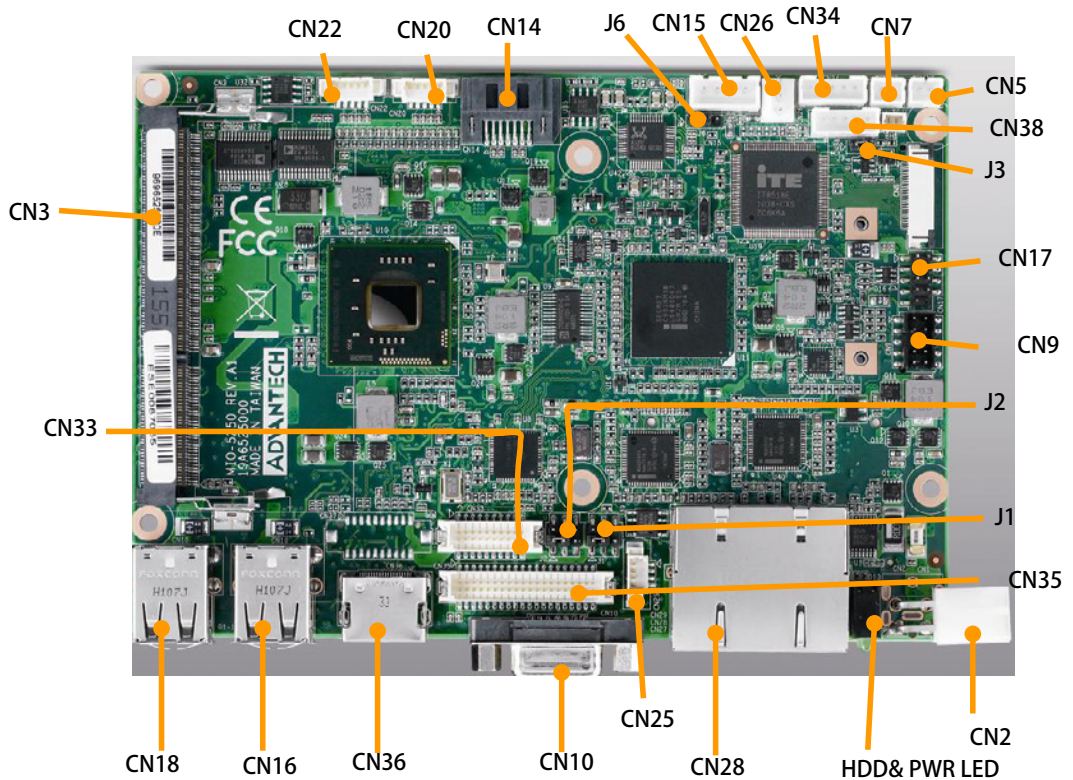

Figure 2.1 Jumper and Connector Layout (Top Side)

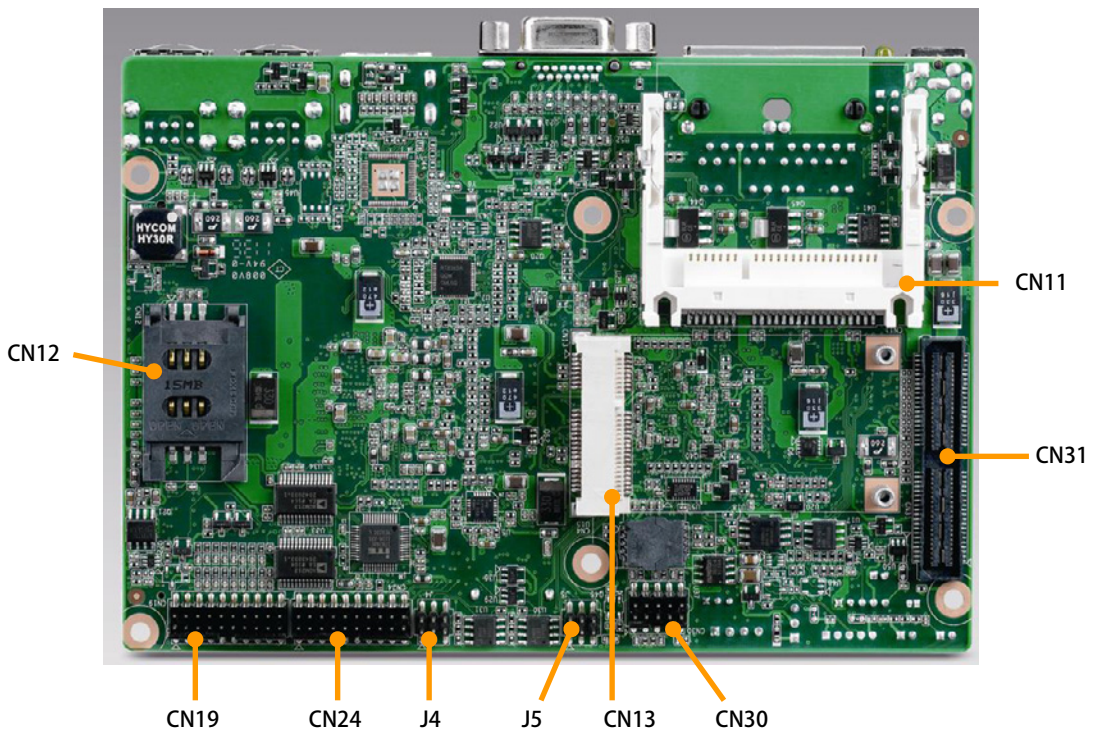

Figure 2.2 Jumper and Connector Layout (Bottom Side)

### 2.3.2 Board Dimensions

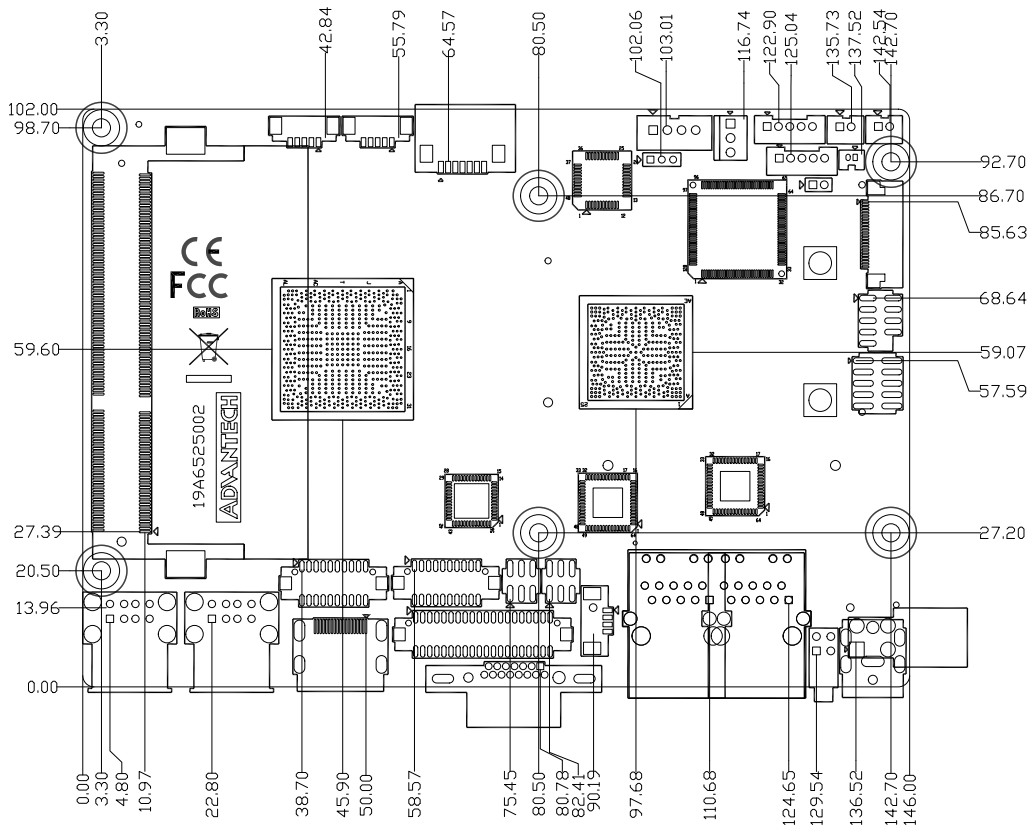

Figure 2.3 Board Dimensions (Component Side)

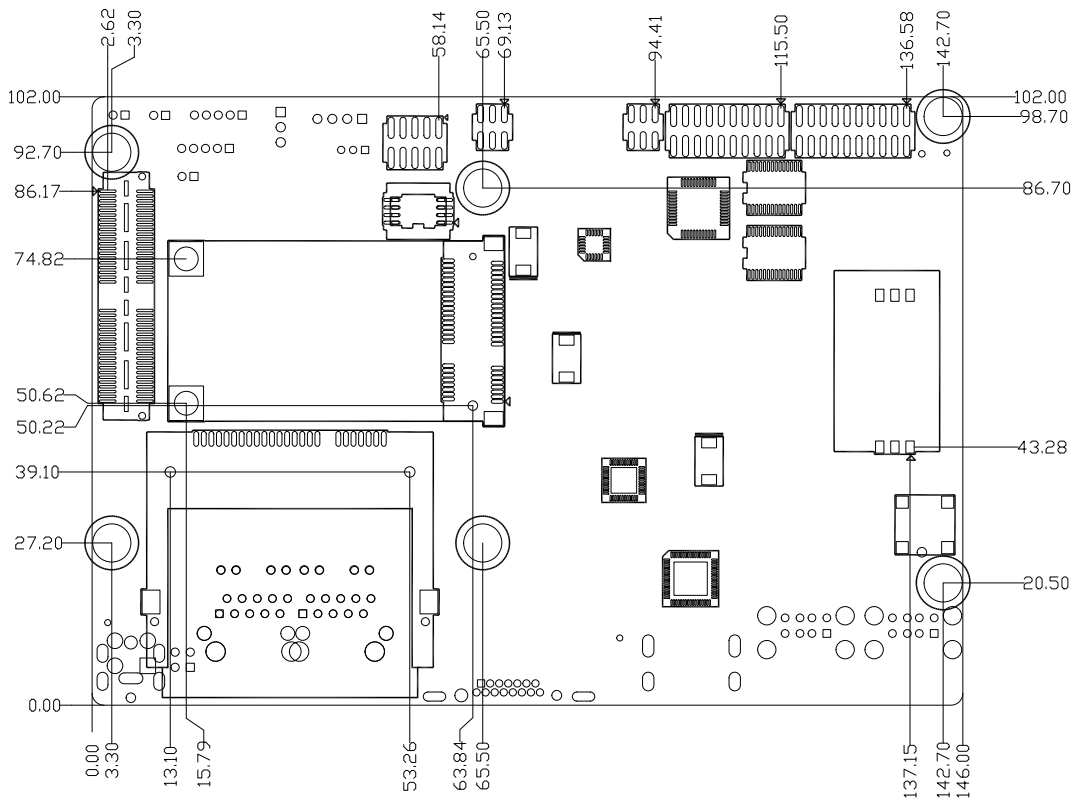
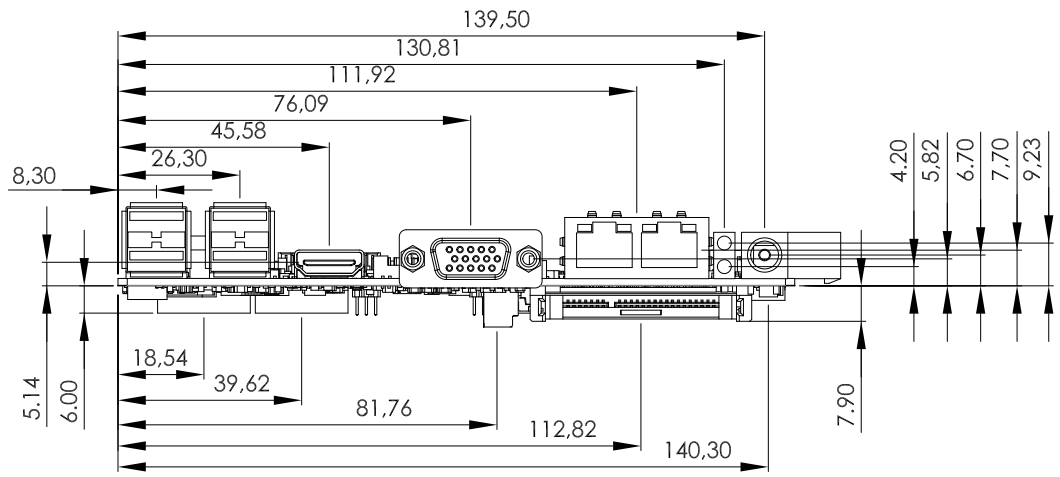

Figure 2.4 Board Dimensions (Solder Side)



**Figure 2.5 I/O Connectors Mechanical Drawing**



# Chapter 3

## BIOS Settings

## 3.1 BIOS Setup

AMIBIOS has been integrated into many motherboards for over a decade. With the AMIBIOS setup program, you can modify BIOS settings and control the various system features. This chapter describes the basic navigation of the MIO-5250 BIOS setup screens.

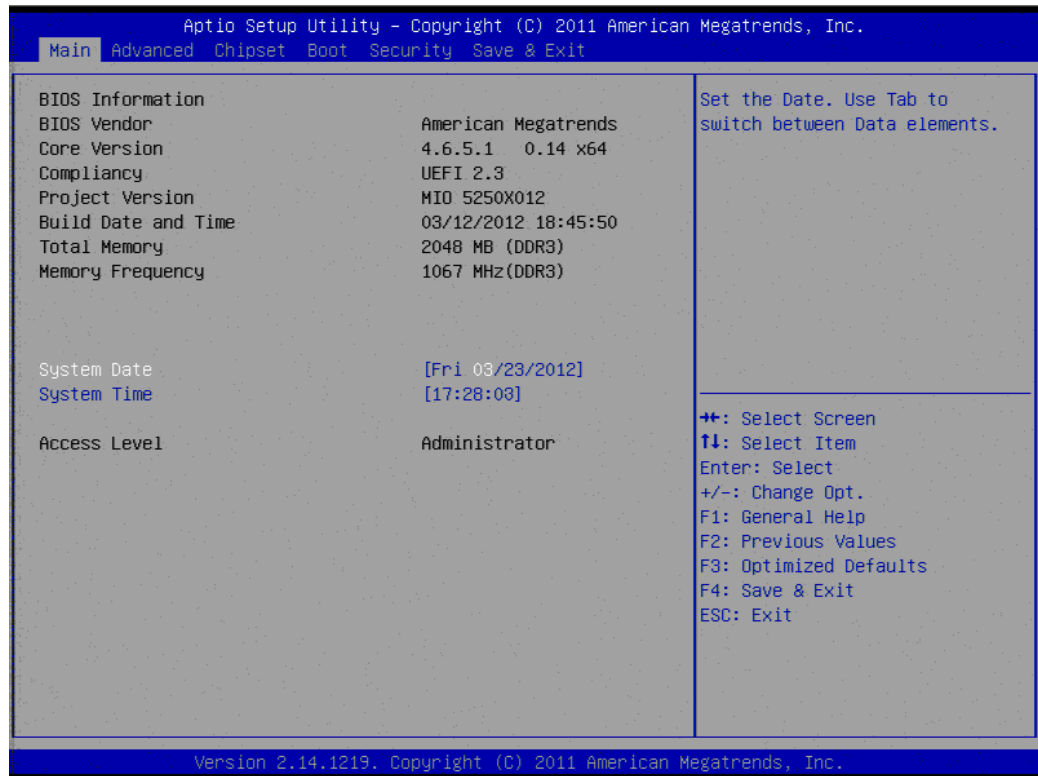

Figure 3.1 Setup program initial screen

AMI's BIOS ROM has a built-in Setup program that allows users to modify the basic system configuration. This information is stored in flash ROM so it retains the Setup information when the power is turned off.

## 3.2 Entering Setup

Turn on the computer and then press <F2> or <DEL> to enter the Setup menu.

## 3.3 Main Setup

When users first enter the BIOS Setup Utility, users will enter the Main setup screen. Users can always return to the Main setup screen by selecting the Main tab. There are two Main Setup options. They are described in this section. The Main BIOS Setup screen is shown below.



**Figure 3.2 Main setup screen**

The Main BIOS setup screen has two main frames. The left frame displays all the options that can be configured. Grayed-out options cannot be configured; options in blue can. The right frame displays the key legend.

Above the key legend is an area reserved for a text message. When an option is selected in the left frame, it is highlighted in white. Often a text message will accompany it.

### 3.3.1 System date / System time

Use this option to change the system time and date. Highlight System Time or System Date using the <Arrow> keys. Enter new values through the keyboard. Press the <Tab> key or the <Arrow> keys to move between fields. The date must be entered in MM/DD/YY format. The time must be entered in HH:MM:SS format.

## 3.4 Advanced BIOS Features Setup

Select the Advanced tab from the MIO-5250 setup screen to enter the Advanced BIOS Setup screen. You can select any of the items in the left frame of the screen, such as CPU Configuration, to go to the sub menu for that item. You can display an Advanced BIOS Setup option by highlighting it using the <Arrow> keys. All Advanced BIOS Setup options are described in this section. The Advanced BIOS Setup screens are shown below. The sub menus are described on the following pages.

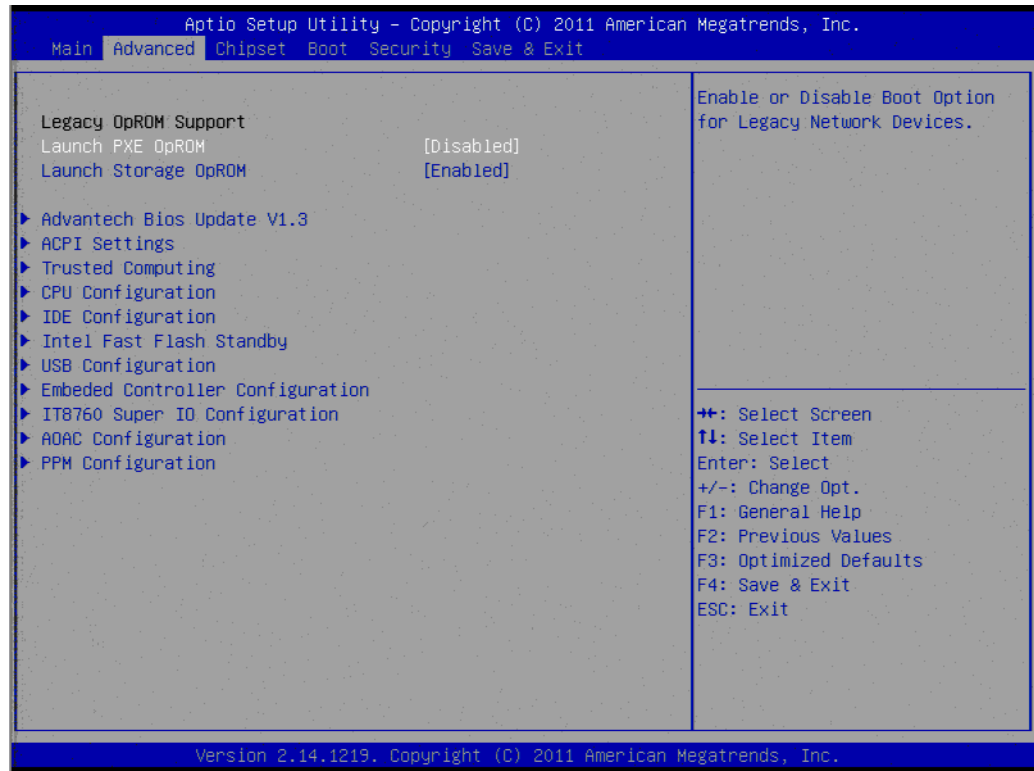

Figure 3.3 Advanced BIOS features setup screen

- **Launch PXE OpROM**  
This item allows users to enable or disable launch PXE OpROM if available.
- **Launch Storage OpROM**  
This item allows users to enable or disable launch storage OpROM if available.

### 3.4.1 Advantech BIOS Update V1.3

This item allows users to flash BIOS.

## 3.4.2 ACPI Settings

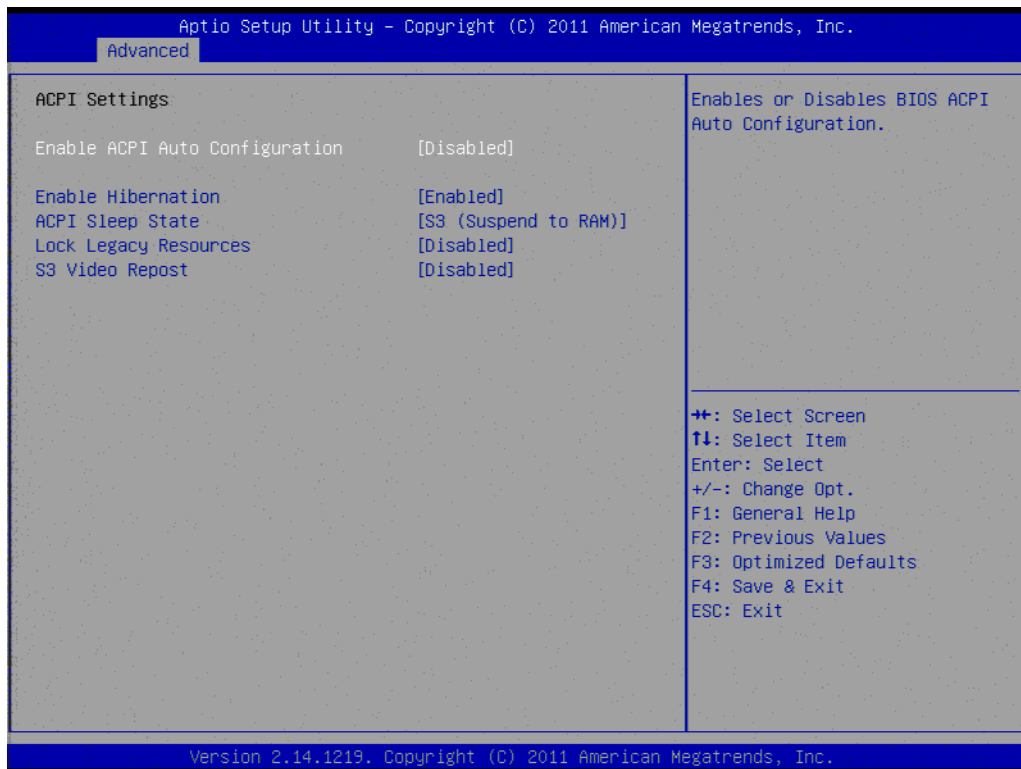

Figure 3.4 ACPI Setting

- **Enable ACPI Auto Configuration**  
This item allows users to enable or disable BIOS ACPI auto configuration.
- **Enable Hibernation**  
This item allows users to enable or disable hibernation.
- **ACPI Sleep State**  
This item allows users to set the ACPI sleep state.
- **Lock Legacy Resources**  
This item allows users to lock legacy devices' resources.
- **S3 Video Report**  
This item allows users to enable or disable S3 resume for VBIOS.

### 3.4.3 TPM Configuration

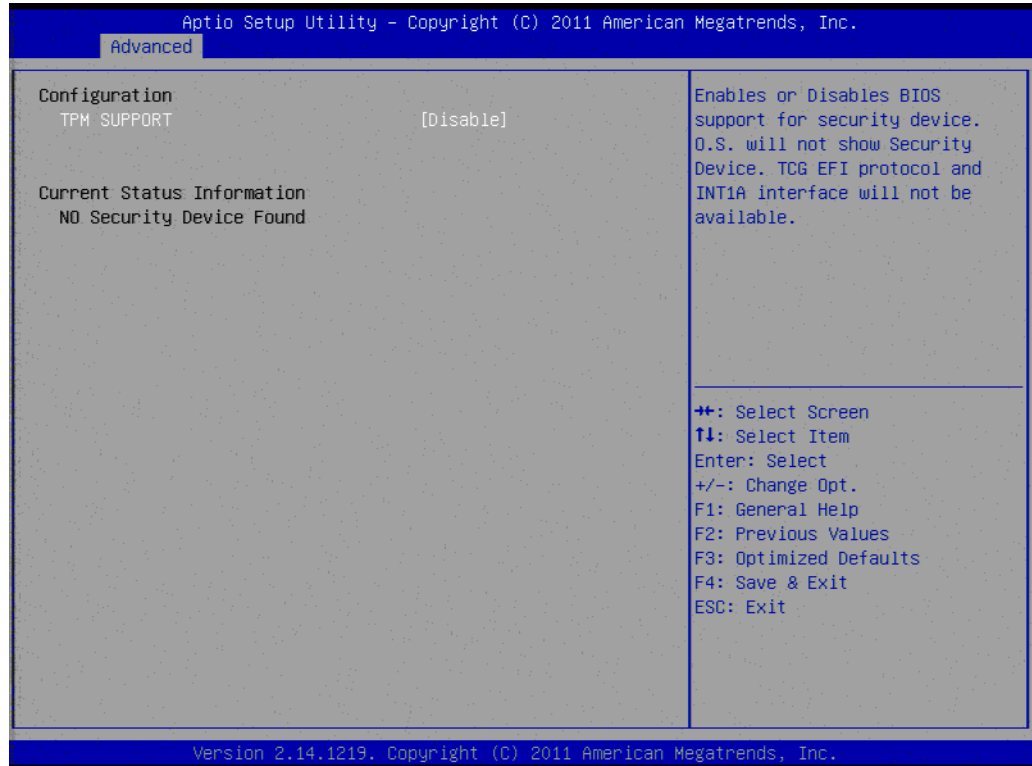

Figure 3.5 TPM Configuration

- **TPM Support**  
 Disable/Enable TPM if available.

### 3.4.4 CPU Configuration

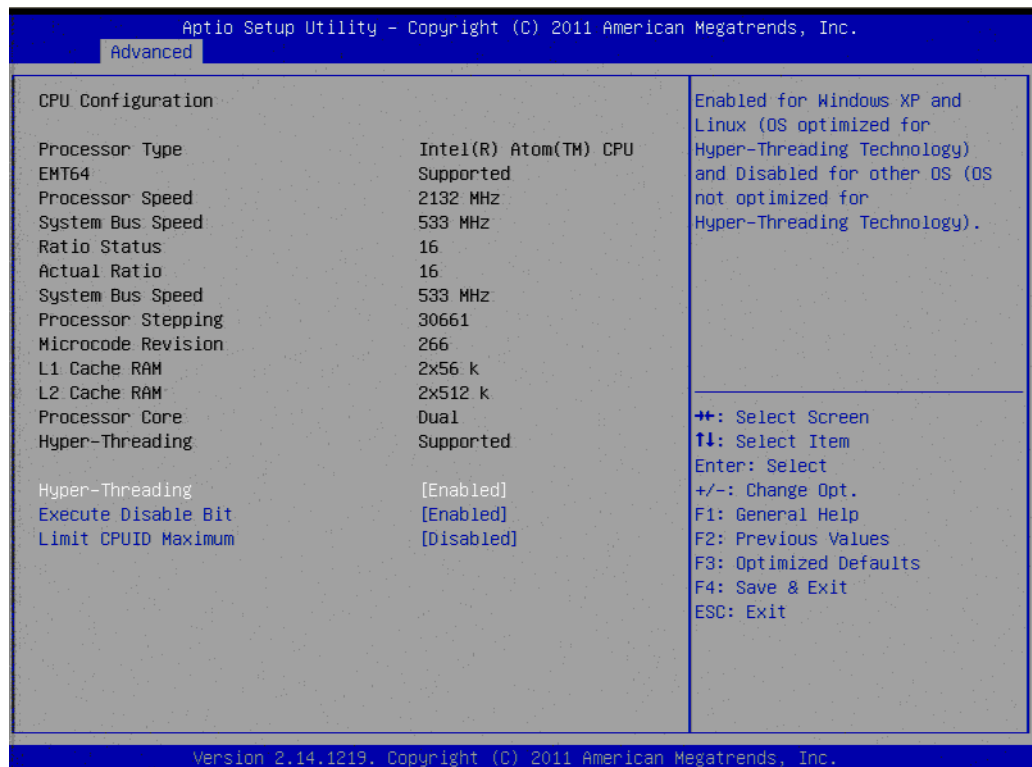

Figure 3.6 CPU Configuration

- **Hyper Threading Technology**  
This item allows users to enable or disable Intel Hyper Threading technology.
- **Execute Disable Bit**  
This item allows users to enable or disable the No-Execution page protection
- **Limit CPUID Maximum**  
This item allows users to enable or disable limit CPUID maximum for Windows XP.

### 3.4.5 SATA Configuration

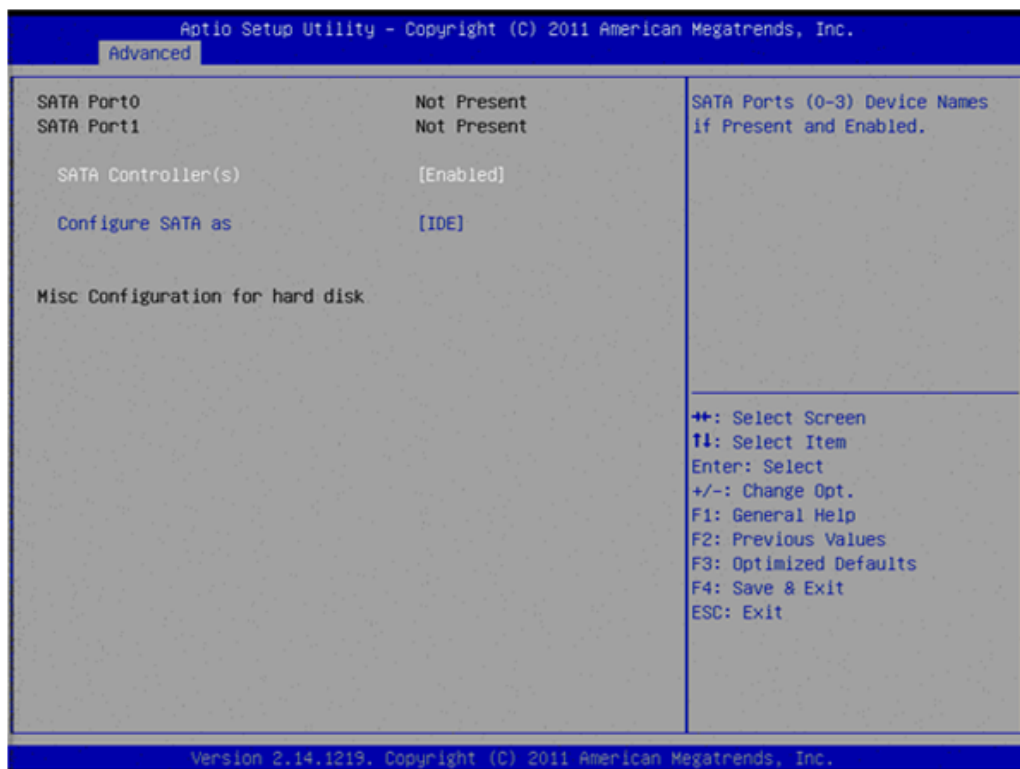

Figure 3.7 SATA Configuration

- **SATA Controller(s)**  
This item allows users to enable or disable the SATA controller(s).
- **SATA Mode Selection**  
This item allows users to select mode of SATA controller(s).

### 3.4.6 Intel Fast Flash Standby

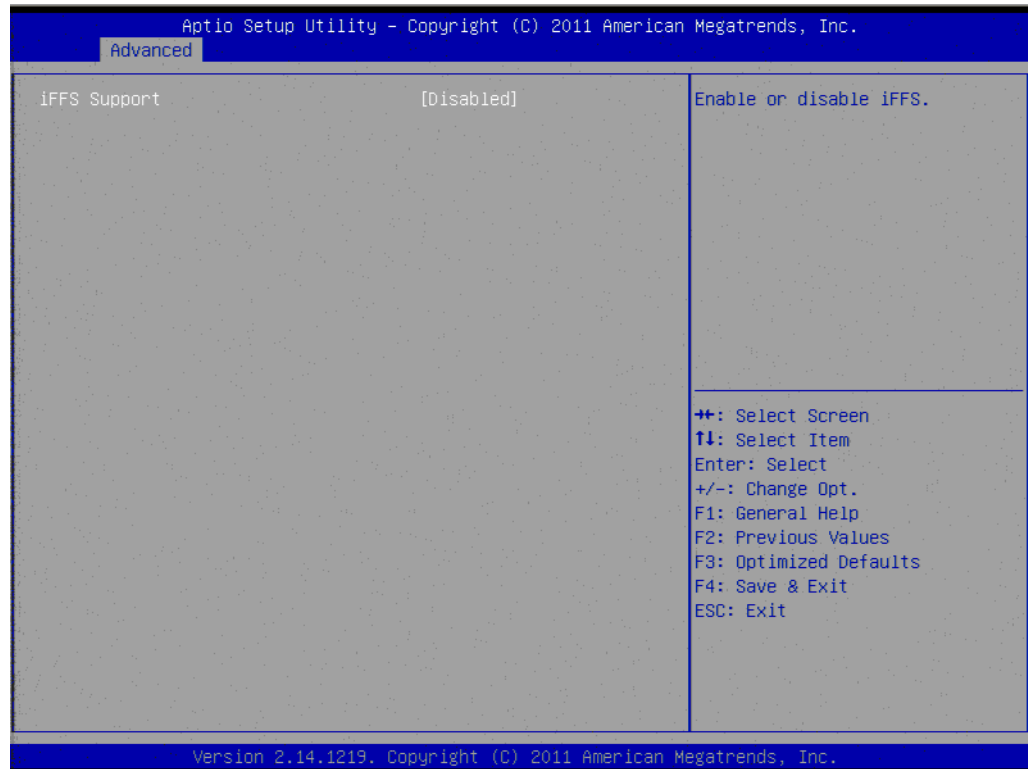

Figure 3.8 Intel Fast Flash Standby

- **IFFS Support**  
This item allows users to enable or disable IFFS.

### 3.4.7 USB Configuration

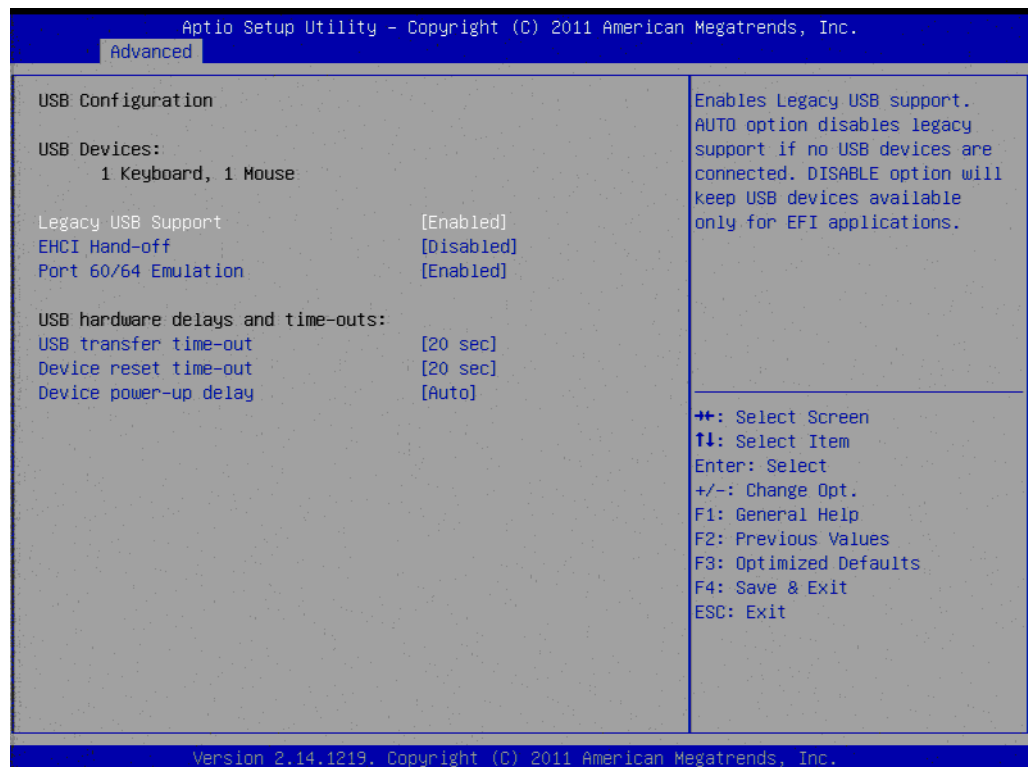

Figure 3.9 USB Configuration



- **Legacy USB Support**  
Enable support for legacy USB. Auto option disables legacy support if no USB devices are connected.
- **EHCI Hand-Off**  
This is a workaround for the OS without EHCI hand-off support. The EHCI ownership change should claim by EHCI driver.
- **Port 60/64 Emulation**  
Enable or disable I/O port 60h/64h emulation support.
- **USB transfer time-out**  
Set the time-out value for Control, Bulk, and Interrupt transfers.
- **Device reset time-out**  
Set USB mass storage device Start Unit command time-out value.
- **Device power-up delay**  
Sets the maximum time the device will take before it properly reports itself to the Host Controller. 'Auto' uses a default value: for a Root port it is 100 ms, for a Hub port the delay is taken from the Hub descriptor.

### 3.4.8 Embedded Controller Configuration



Figure 3.10 Embedded Controller Configuration

- **EC iManager WatchDog IRQ**  
This item allows users to set the IRQ number of EC watchdog.
- **EC Power Saving Mode**  
This item allows users to set board's power saving mode when off.
- **Backlight Enable Polarity**  
This item allows users to set backlight enable polarity.
- **Backlight Mode**  
This item allows users to set backlight mode.
- **Backlight Mode 1**  
This item allows users to set backlight mode 1.

## 3.4.9 Super I/O Configuration

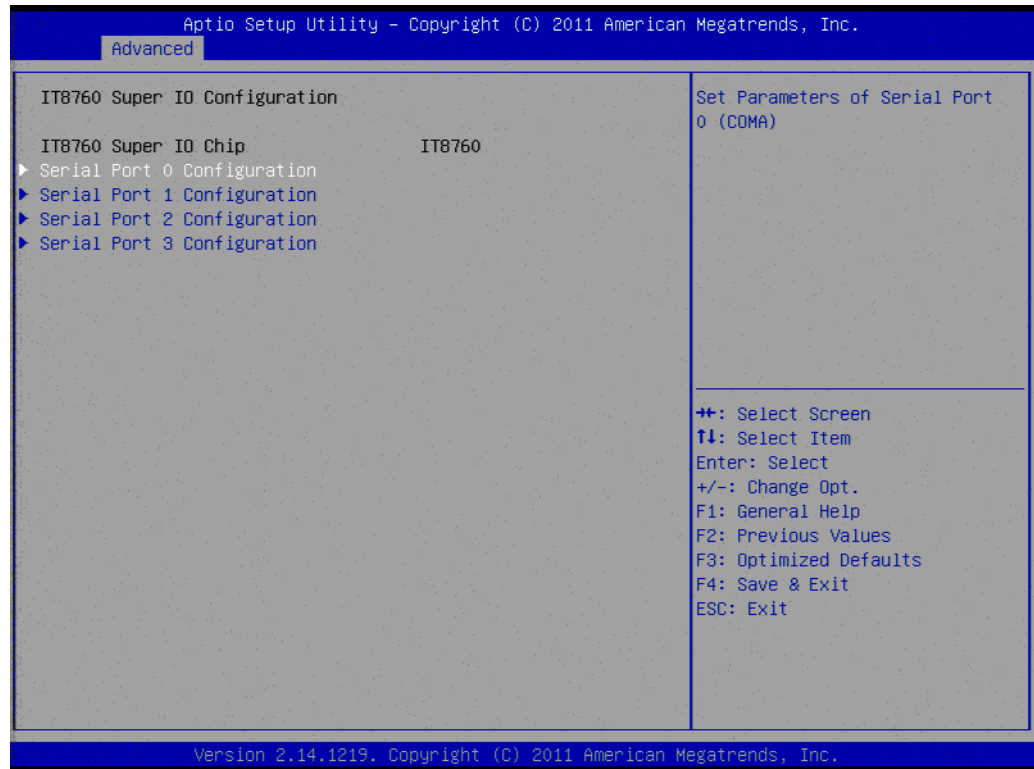

**Figure 3.11 Super IO Configuration**

- **Serial Port 0 Configuration**  
This item allows users to configure serial port 0.
- **Serial Port 1 Configuration**  
This item allows users to configure serial port 1.
- **Serial Port 2 Configuration**  
This item allows users to configure serial port 2.
- **Serial Port 3 Configuration**  
This item allows users to configure serial port 3.

### 3.4.10 AOAC Configuration



Figure 3.12 AOAC Configuration

- AOAC Configuration  
This item allows users to enable or disable AOAC function.

### 3.4.11 PPM Configuration

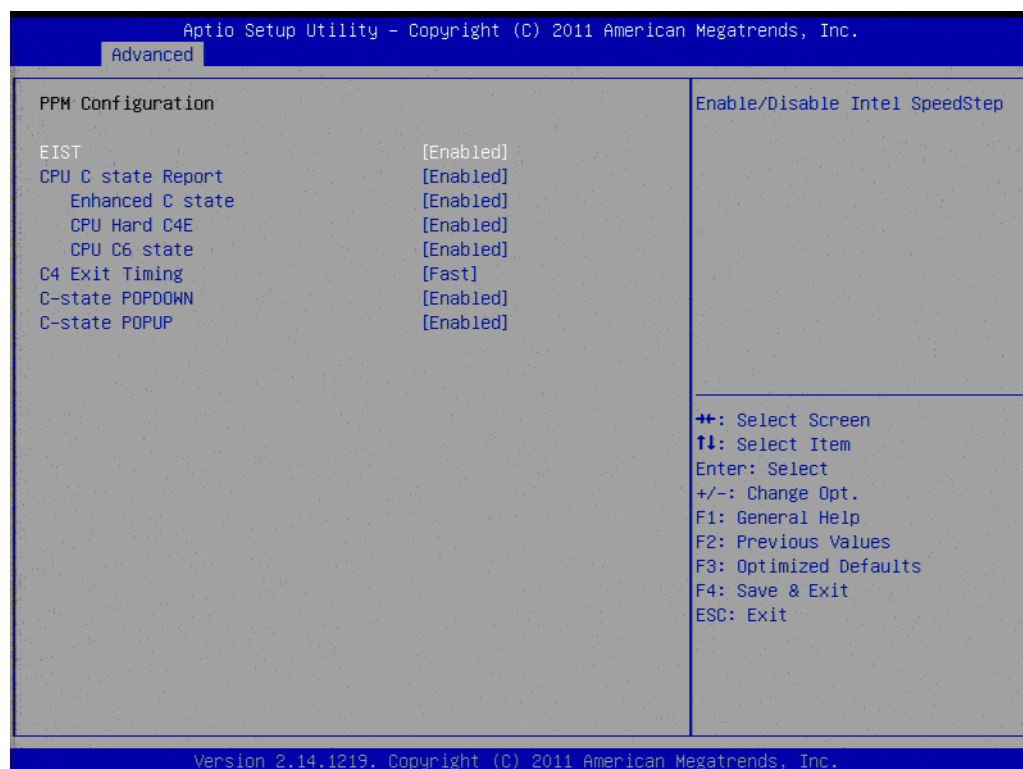

Figure 3.13 PPM Configuration

- **EIST**  
This item allows users to enable or disable Intel SpeedStep function.
- **CPU C state Report**  
This item allows users to enable or disable CPU C state report to OS.
- **Enhanced C state**  
This item allows users to enable or disable Enhanced CPU C state.
- **CPU Hard C4E**  
This item allows users to enable or disable CPU Hard C4E function.
- **CPU C6 state**  
This item allows users to enable or disable CPU C6 state.
- **C4 Exit Timing**  
This item allows users to control a programmable time for the CPU voltage to stabilize when exiting from a C4 state.
- **C-state POPDOWN**  
This item allows users to enable or disable Intel C-state POPDOWN function.
- **C-state POPUP**  
This item allows users to enable or disable Intel C-state POPUP function.

## 3.5 Chipset Configuration

Select the Chipset tab from the MIO-5250 setup screen to enter the Chipset BIOS Setup screen. You can display a Chipset BIOS Setup option by highlighting it using the <Arrow> keys. All Plug and Play BIOS Setup options are described in this section.

The Plug and Play BIOS Setup screen is shown below.

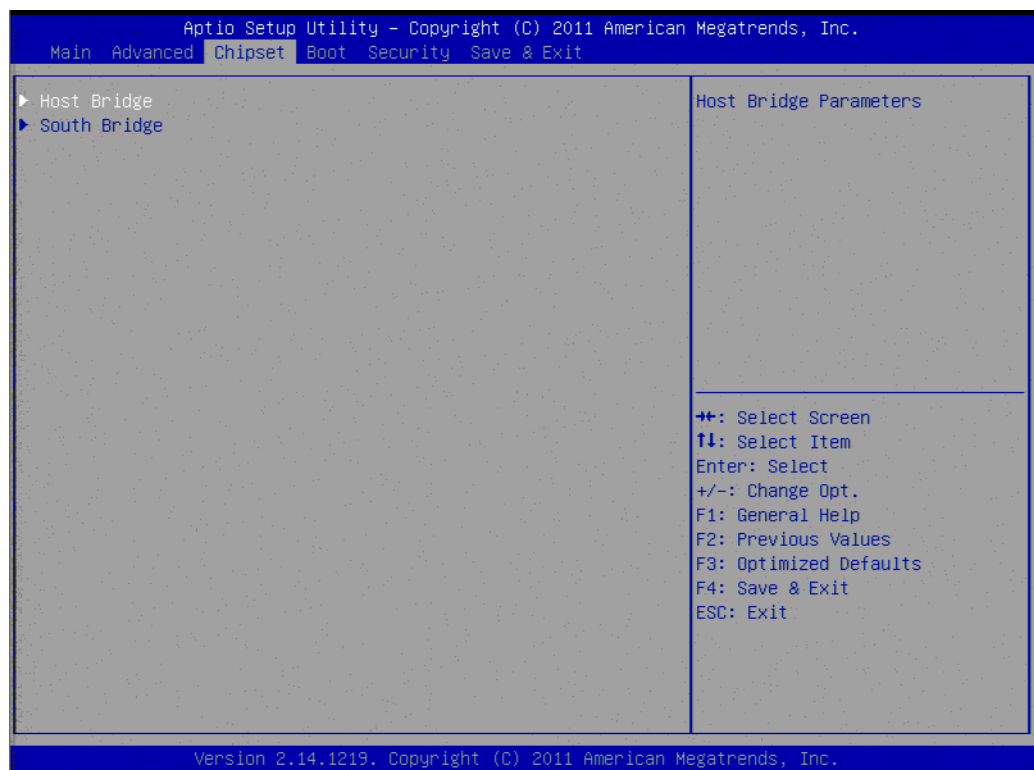

Figure 3.14 Chipset Setup

### 3.5.1 Host Bridge/Intel IGD Configuration

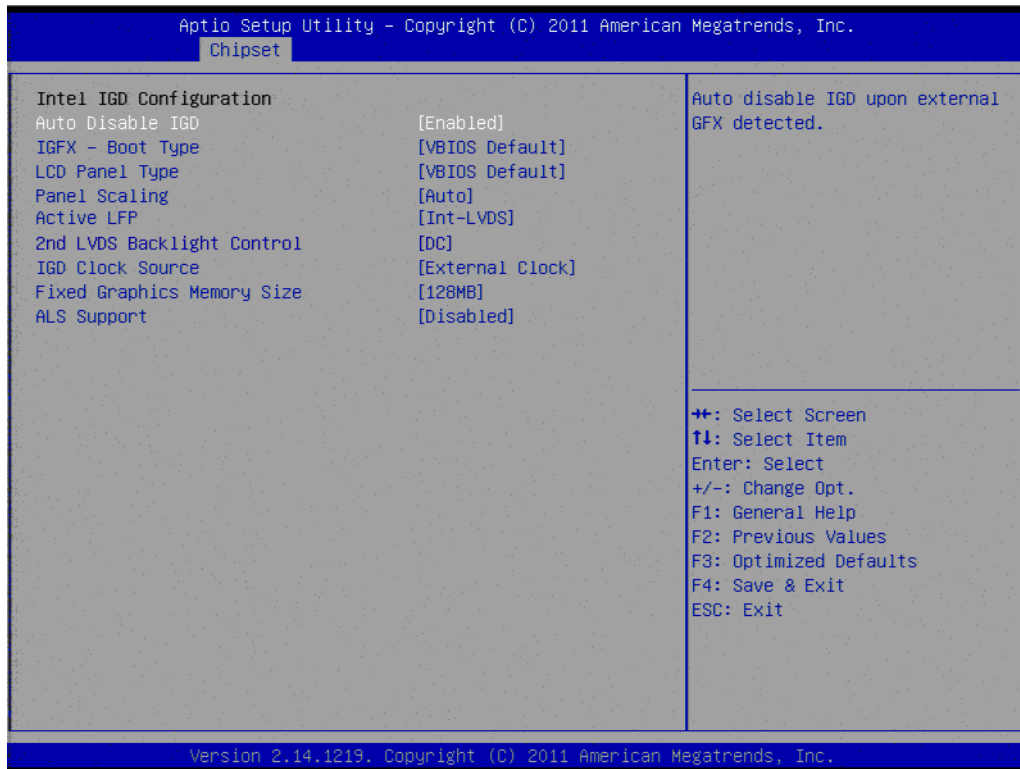

Figure 3.15 Intel IGD Configuration

- **Auto Disable IGD**  
This item allows users to auto disable IGD upon external GFX detected.
- **IGFX - Boot Type\***  
This item allows users to select which output device during POST.
- **LCD Panel Type**  
This item allows users to select LCD panel by internal graphic device.
- **Panel Scaling**  
This item allows users to select LCD panel scaling by internal graphic device.
- **Active LFP\***  
This item allows users to select the active LFP configuration.
- **2nd LVDS Backlight Control**  
This item allows users to select 2nd backlight control.
- **IGD Clock Source**  
This item allows users to select IGD clock.
- **Fixed Graphics Memory Size**  
This item allows users to configure fixed graphic memory size.
- **ALS Support**  
This item allows users to select ASL support for ACPI.

\*Since Intel Cedar Trail platform has some limitation on **Display Combination** (Refer to Boot Display Configuration on Intel® Atom™ Processor D2000 and N2000 Series (Cedar Trail Platform), Application Note 513764), the following selection items need to match with below table as display device attached.

Boot type display	Active_LFP	NOTE
CRT	#No_LVDS	
LFP(LVDS1)	#INT-LVDS	
EFP(HDMI)	#No_LVDS	It only supports Graphic Mode under DOS environment.
EFP1(LVDS2)	#LVDS 2	EFP1 will be item "built-in display" in driver device list
CRT+LFP	#INT-LVDS	Dual Display is only supported with Graphic Mode under DOS environment.
CRT+EFP	#No_LVDS	Dual Display is only supported with Graphic Mode under DOS environment.
CRT+EFP1	#LVDS 2	Dual Display is only supported with Graphic Mode under DOS environment.
LFP+EFP	#INT-LVDS	Dual Display is only supported with Graphic Mode under DOS environment.
EFP+EFP1	#LVDS 2	In BIOS setup menu, it only has display on EFP1. Dual Display is only supported with Graphic Mode under DOS environment.

### 3.5.2 South Bridge

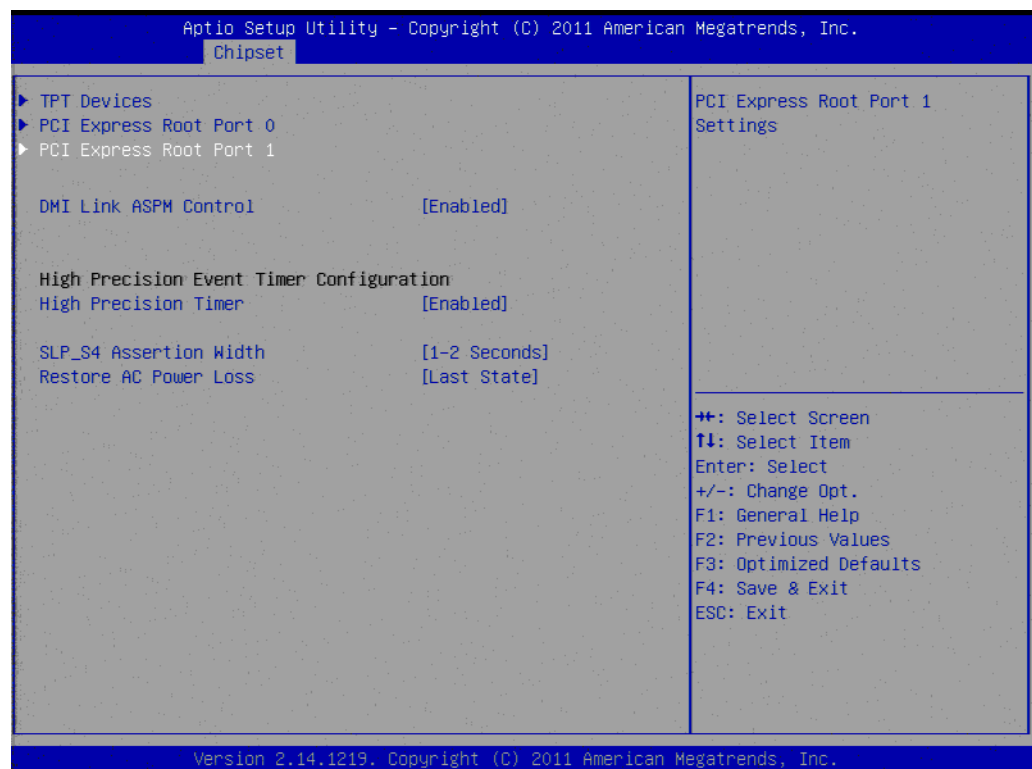

Figure 3.16 South Bridge

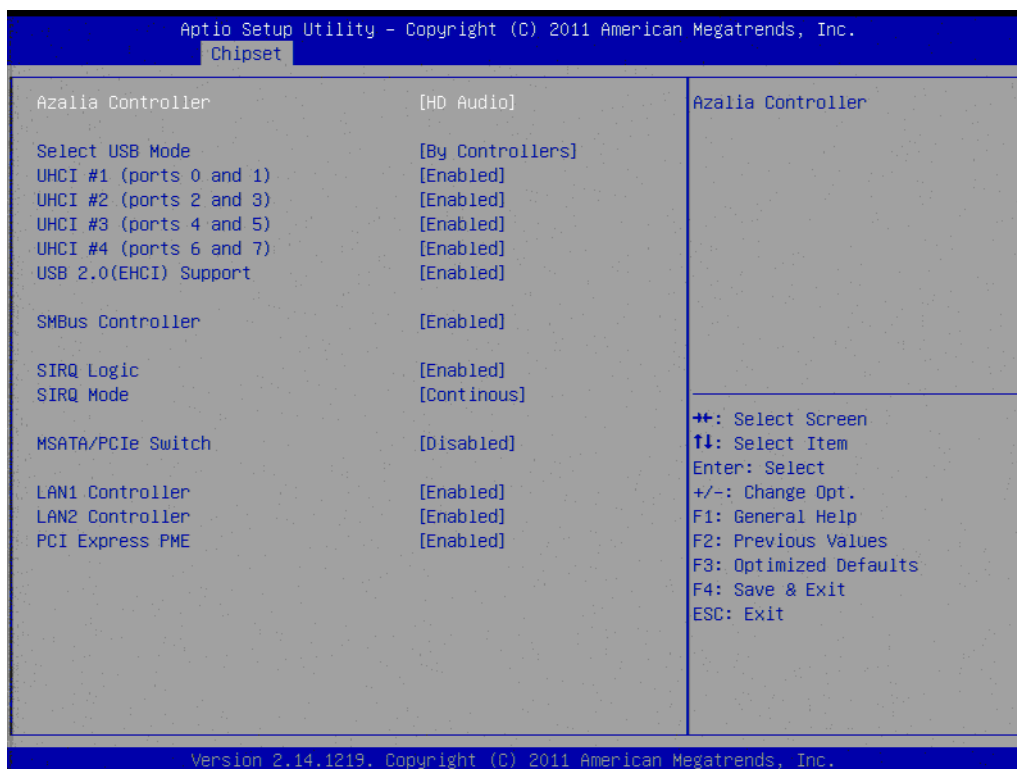

Figure 3.17 TPT Device

- **Azalia Controller**  
Enables or disables the azalia controller.
- **Select USB Mode**  
Select USB mode by controllers or ports.
- **SMBus Controller**  
Enables or disables the onchip SMBus controller.
- **SIRQ Logic**  
Enables or disables the SIRQ logic.
- **SIRQ Mode**  
Set SIRQ mode.
- **MSATA/PCIe Switch**  
Enables for MSATA disables for PCIe.
- **LAN1/LAN2 Controller**  
This item allows users to enables or disables LAN device.
- **PCI Express PME**  
This item allows users to enables or disables PCIe PME function.
- **PCI Express Root Port 0/1**  
This item allows users to config PCIe port 0/1 settings.
- **DMI Link ASPM Control**  
This item Enables or disables control of active state power management on both NB and SB side of DMI link.
- **High Precision Timer**  
Enables or disables the high precision timer.
- **SLP\_S4 Assertion Width**  
This item allows users to set a delay of sorts.
- **Restore AC Power Loss**

## 3.6 Boot Settings

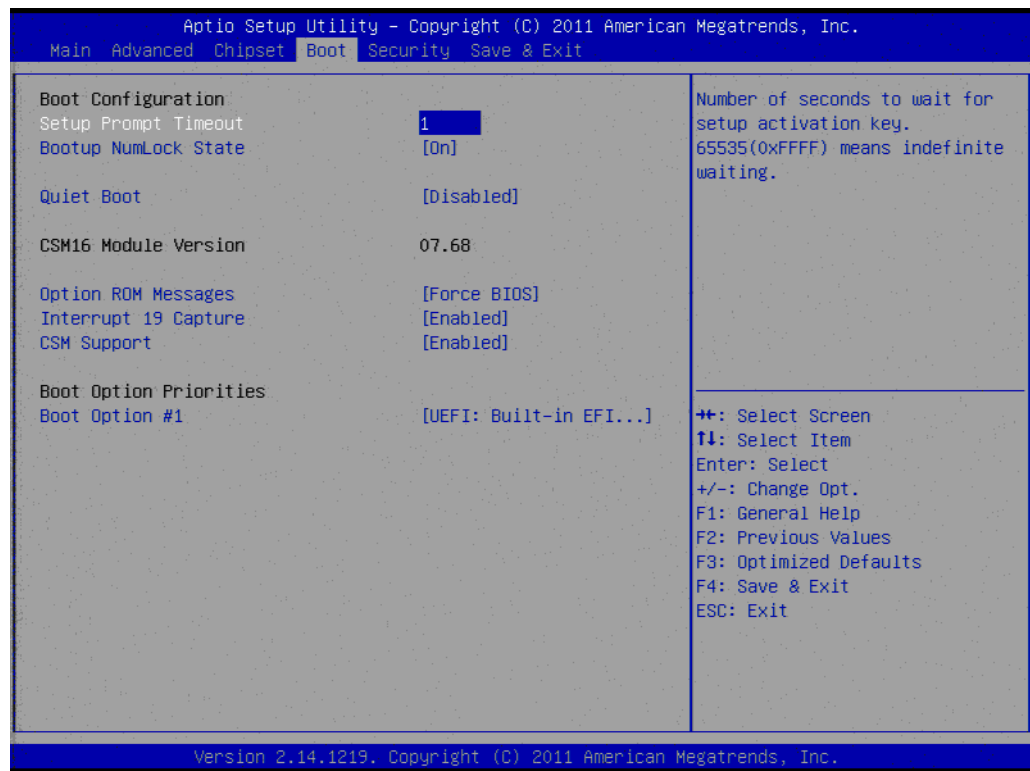
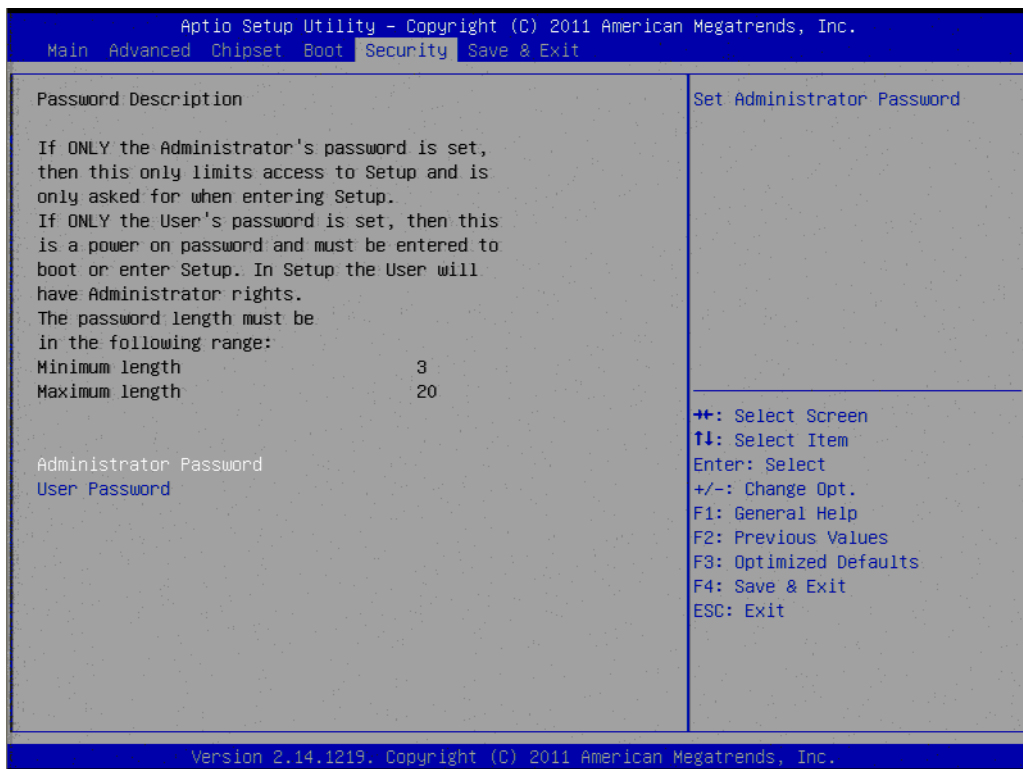

Figure 3.18 Boot Setup Utility

- **Setup Prompt Timeout**  
This item allows users to select the number of seconds to wait for setup activation key.
- **Bootup NumLock State**  
Select the Power-on state for Numlock.
- **Quiet Boot**  
If this option is set to Disabled, the BIOS displays normal POST messages. If Enabled, an OEM Logo is shown instead of POST messages.
- **Option ROM Message**  
Set display mode for option ROM.
- **Interrupt 19 Capture**  
This item allows option ROMs to trap interrupt 19.
- **1st/2nd/3rd/4th/5th/6th/7th Boot**  
This item allows users to set boot device priority.



## 3.7 Security Setup



**Figure 3.19 Password Configuration**

Select Security Setup from the MIO-5250 Setup main BIOS setup menu. All Security Setup options, such as password protection is described in this section. To access the sub menu for the following items, select the item and press <Enter>:

- **Change Administrator / User Password**  
Select this option and press <ENTER> to access the sub menu, and then type in the password.

## 3.8 Save & Exit

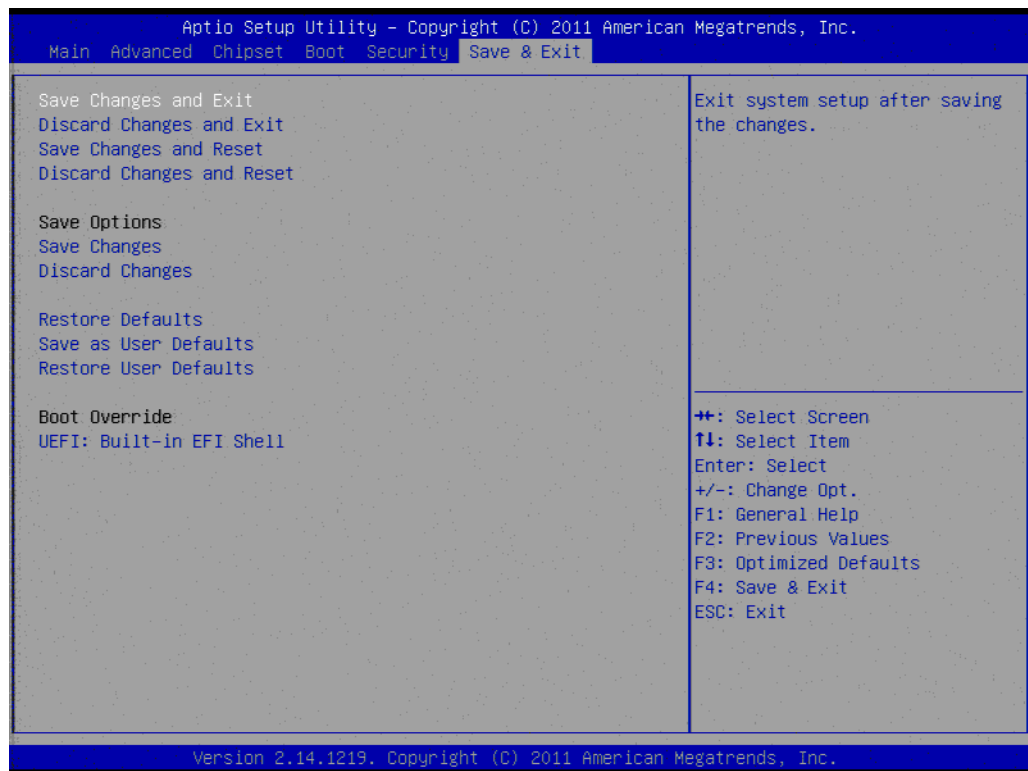

Figure 3.20 Save & Exit

### 3.8.1 Save Changes and Exit

When users have completed system configuration, select this option to save changes, exit BIOS setup menu and reboot the computer if necessary to take effect of all system configuration parameters.

### 3.8.2 Discard Changes and Exit

Select this option to quit Setup without making any permanent changes to the system configuration.

### 3.8.3 Save Changes and Reset

When users have completed system configuration, select this option to save changes, exit the BIOS setup menu and reboot the computer to take effect of all system configuration parameters.

### 3.8.4 Discard Changes and Reset

Select this option to quit Setup without making any permanent changes to the system configuration and reboot the computer.

### 3.8.5 Save Changes

When users have completed system configuration, select this option to save changes without exiting the BIOS setup menu.

### **3.8.6 Discard Changes**

Select this option to discard any current changes and load previous system configuration.

### **3.8.7 Restore Defaults**

The MIO-5250 automatically configures all setup items to optimal settings when users select this option. Optimal Defaults are designed for maximum system performance, but may not work best for all computer applications. In particular, do not use the Optimal Defaults if the user's computer is experiencing system configuration problems.

### **3.8.8 Save User Defaults**

When users have completed system configuration, select this option to save changes as user defaults without exit BIOS setup menu.

### **3.8.9 Restore User Defaults**

The users can select this option to restore user defaults.

### **3.8.10 Boot Override**

You select device you want to do boot override.



# Chapter 4

MIOe Installation

The MI/O compact form factor SBC is a new-generation SBC design with a variety of mechanical improvements. Here is the quick installation guide for our thermal design and MIOe module installation.

### Quick Installation Guide:

1. There is a Heatsink / Cooler in the white box inside the package. Carefully remove the release paper from the thermal pad before installation.

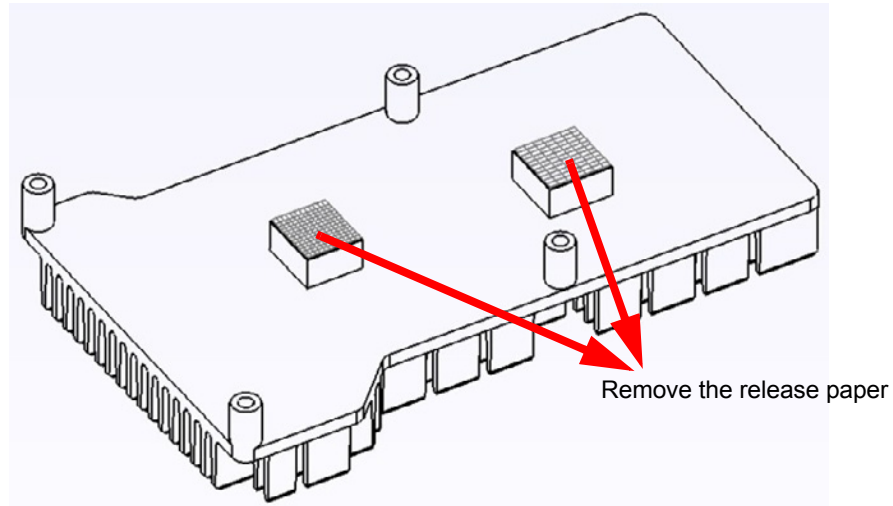

2. There are six screws inside the white box; please install DRAM in the SO-DIMM socket first, then screw the heatsink as shown below. Four long screws are for the heatsink; two shorter screws are for the main board.
3. There are six standoff's on the MIOe module which can also be installed with the screws and copper studs.

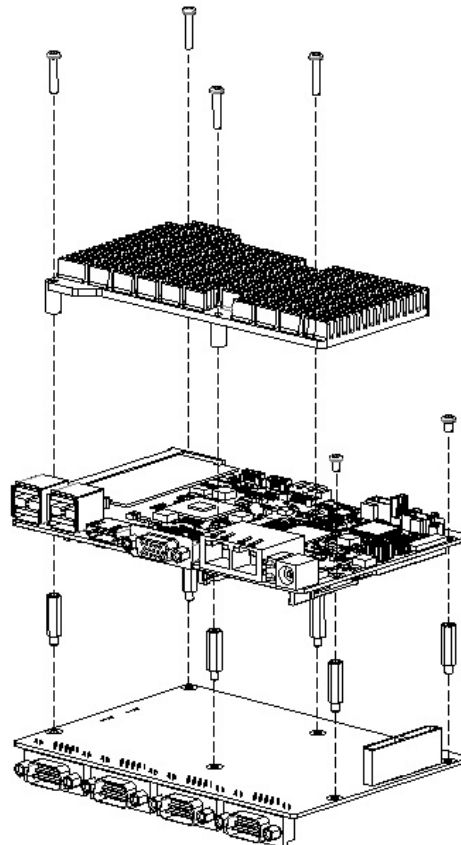

# Appendix **A**

## Pin Assignments

<b>CN1</b>	12V Power Input
<b>Part Number</b>	1655003865
<b>Footprint</b>	WF_2x2P_165_BOX_RA_D_740SP
<b>Description</b>	
Pin	Pin Name
1	GND
2	GND
3	+12V
4	+12V

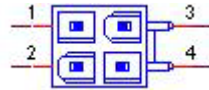

<b>CN2</b>	DC JACK
<b>Part Number</b>	1652005624
<b>Footprint</b>	PJ_2P_2DC-G213B200
<b>Description</b>	
Pin	Pin Name
1	+VIN
2	GND

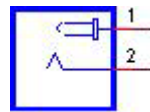

<b>CN3</b>	SODIMMDDR3RVS_204
<b>Part Number</b>	1651001648
<b>Footprint</b>	DDR3_204P_2-2013311-1
<b>Description</b>	
Pin	Pin Name

<b>CN5</b>	<b>Power Switch</b>
<b>Part Number</b>	1655302020
<b>Footprint</b>	WF_2P_79_BOX_R1_D
<b>Description</b>	
Pin	Pin Name
1	PSIN
2	GND

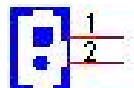



<b>CN7</b>	<b>Reset</b>
<b>Part Number</b>	1655302020
<b>Footprint</b>	WF_2P_79_BOX_R1_D
<b>Description</b>	WAFER BOX 2P 2.0mm 180D(M) DIP A2001WV2-2P
<b>Pin</b>	<b>Pin Name</b>
1	RESET#
2	GND

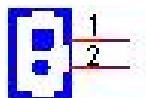

<b>CN9</b>	<b>GPIO</b>
<b>Part Number</b>	1653004099
<b>Footprint</b>	HD_5x2P_79_23N685B-10M10
<b>Description</b>	BOX HEADER 5x2P 2.00mm 180D(M) SMD 23N685B-10M10
<b>Pin</b>	<b>Pin Name</b>
1	+5V
2	GPIO4
3	GPIO0
4	GPIO5
5	GPIO1
6	GPIO6
7	GPIO2
8	GPIO7
9	GPIO3
10	GND

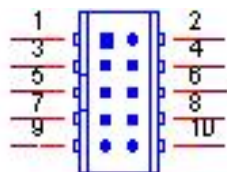

<b>CN10</b>	<b>VGA</b>
<b>Part Number</b>	1654000055
<b>Footprint</b>	DBVGA-VF5MS
<b>Description</b>	D-SUB Conn. 15P 90D(F) DIP 070242FR015S200ZU
<b>Pin</b>	<b>Pin Name</b>
1	RED
2	GREEN
3	BLUE
4	NC
5	GND
6	GND
7	GND
8	GND
9	NC
10	GND
11	NC
12	DDAT
13	HSYNC
14	VSYNC
15	DCLK

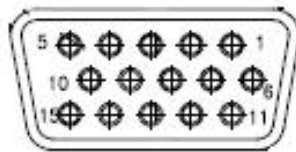

<b>CN11</b>	<b>CFast</b>
<b>Part Number</b>	1653004849
<b>Footprint</b>	CFAST_24P_N7G24
<b>Description</b>	CFast 24P 1.27mm 90D(M) SMD N7G24-A0B2RA-10-0HT-
<b>Pin</b>	<b>Pin Name</b>
PC1	CDI
PC2	GND
PC3	NC
PC4	NC
PC5	NC
PC6	NC
PC7	GND
PC8	NC
PC9	NC
PC10	NC
PC11	NC
PC12	NC

PC13	+3.3V
PC14	+3.3V
PC15	GND
PC16	GND
PC17	CDO
S1	GND
S2	TX+
S3	TX-
S4	GND
S5	RX-
S6	RX+
S7	GND

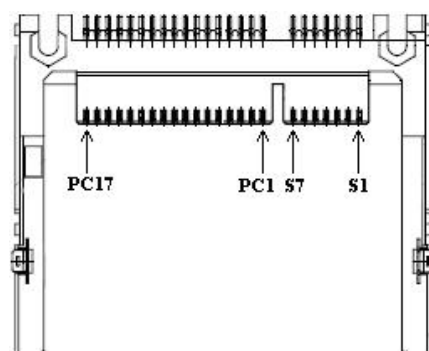

<b>CN12</b>	<b>SIM</b>
<b>Part Number</b>	1654000639
<b>Footprint</b>	SIM-WL608C
<b>Description</b>	SIM card conn 6p 90D(F)SMD WO/Pb WL608C3-M04-7F
<b>Pin</b>	<b>Pin Name</b>
1	UIM_PWR
2	UIM_RESET
3	UIM_CLK
4	GND
5	UIM_VPP
6	UIM_DATA

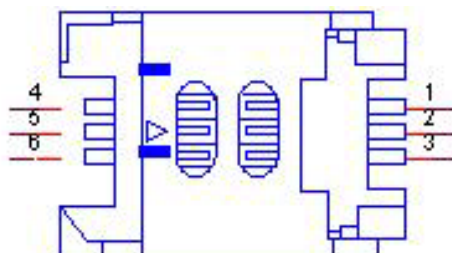

<b>CN13</b>	<b>Mini PCIE</b>
<b>Part Number</b>	1654006715
<b>Footprint</b>	MINIPCI_52P_88911-5204M
<b>Description</b>	
Pin	Pin Name
1	WAKE#
2	+3.3VSB
3	NC
4	GND
5	NC
6	+1.5V
7	MINI_CLKREQ#
8	+VUIM_PWR
9	GND
10	UIM_DATA
11	REFCLK-
12	UIM_CLK
13	REFCLK+
14	UIM_RESET
15	GND
16	+VUIM_VPP
17	NC
18	GND
19	NC
20	NC
21	GND
22	PERST#
23	PERn0
24	+3.3VSB
25	PERp0
26	GND
27	GND
28	+1.5V
29	GND
30	SMB_CLK
31	PETn0
32	SMB_DAT
33	PETp0
34	GND
35	GND
36	USB D-
37	GND
38	USB D+
39	+3.3VSB
40	GND
41	+3.3VSB
42	NC
43	GND

44	NC
45	NC
46	NC
47	NC
48	+1.5V
49	NC
50	GND
51	NC
52	+3.3VSB
H3	GND
H4	GND
H5	NC
H6	NC

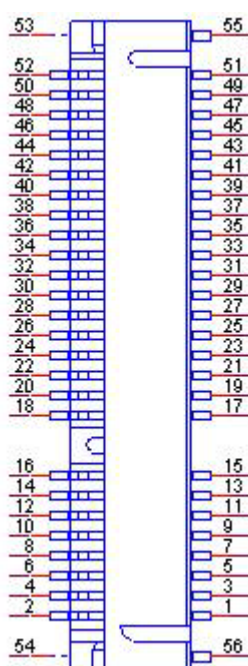

<b>CN14</b>	<b>SATA</b>
<b>Part Number</b>	1654004118
<b>Footprint</b>	SATA_7P_50_WATA-07DPLH4U
<b>Description</b>	Serial ATA 7P 1.27mm 90D(M) SMD WATA-07DPLH4U
<b>Pin</b>	<b>Pin Name</b>
1	GND
2	TX+
3	TX-
4	GND
5	RX-
6	RX+
7	GND

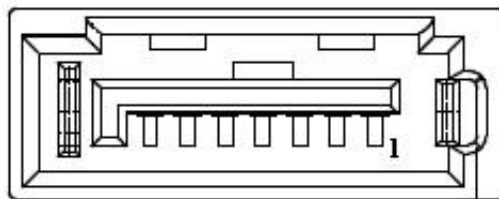

<b>CN15</b>	<b>SATA Power</b>
<b>Part Number</b>	1655001154
<b>Footprint</b>	WF_4P_98_BOX_R1_D
<b>Description</b>	WAFER BOX 4P 2.50mm 180D(M) DIP 24W1170-04S10-01
<b>Pin</b>	<b>Pin Name</b>
1	+5V
2	GND
3	GND
4	+12V

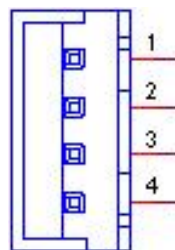

<b>CN16</b>	USB3/4
<b>Part Number</b>	1654009513
<b>Footprint</b>	USB_8P_UB1112C-8FDE-4F
<b>Description</b>	USB CONN. 8P 2.0mm 90D DIP UB1112C-8FDE-4F
<b>Pin</b>	<b>Pin Name</b>
1	+5V
2	D-
3	D+
4	GND

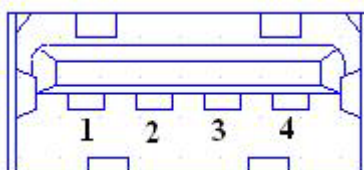

<b>CN17</b>	<b>Internal USB</b>
<b>Part Number</b>	1653005260
<b>Footprint</b>	HD_5x2P_79_N10
<b>Description</b>	PIN HEADER 2x5P 2.0mm 180D(M) SMD 21N22050
<b>Pin</b>	<b>Pin Name</b>
1	+5V
2	+5V
3	A_D-
4	B_D-
5	A_D+
6	B_D+
7	GND
8	GND
9	GND

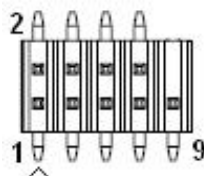

Matching Cable: 1703100260 1703100121

<b>CN18</b>	USB 1/2
<b>Part Number</b>	1654009513
<b>Footprint</b>	USB_8P_UB1112C-8FDE-4F
<b>Description</b>	USB CONN. 8P 2.0mm 90D DIP UB1112C-8FDE-4F
<b>Pin</b>	<b>Pin Name</b>
1	+5V
2	D-
3	D+
4	GND

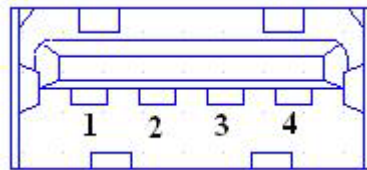

<b>CN19</b>	<b>COM1/COM2 RS-232</b>
<b>Part Number</b>	1653004793
<b>Footprint</b>	HD_10x2P_79_23N685B-20M10
<b>Description</b>	BOX HEADER 10x2P 2.0mm 180D(M)SMD 23N685B-20M10B
<b>Pin</b>	<b>Pin Name</b>
1	DCD1#
2	DSR1#
3	RXD1
4	RTS1#
5	TXD1
6	CTS1#
7	DTR1#
8	RI1#
9	GND
10	GND
11	DCD2#
12	DSR2#
13	RXD2
14	RTS2#
15	TXD2
16	CTS2#
17	DTR2#
18	RI2#
19	GND
20	GND



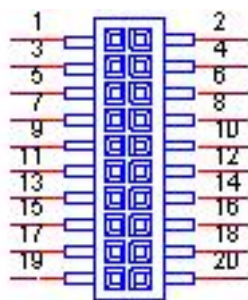

Matching Cable: 1701200220

<b>CN20</b>	<b>RS422/485 1</b>
<b>Part Number</b>	1655304032
<b>Footprint</b>	WF_5P_49_BOX_85205
<b>Description</b>	WAFER 5P 1.25mm 180D(M) SMD 85205-05701
<b>Pin</b>	<b>Pin Name</b>
1	422RX-
2	422RX+
3	422/485TX+
4	422/485TX-
5	GND

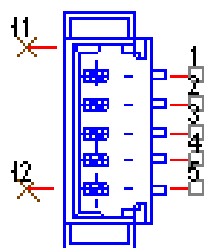

WB\_5V\_1.25mm

<b>CN22</b>	<b>RS422/485 2</b>
<b>Part Number</b>	1655304032
<b>Footprint</b>	WF_5P_49_BOX_85205
<b>Description</b>	WAFER 5P 1.25mm 180D(M) SMD 85205-05701
<b>Pin</b>	<b>Pin Name</b>
1	422RX-
2	422RX+
3	422/485TX+
4	422/485TX-
5	GND

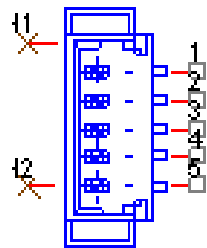

WB\_5V\_1.25mm

<b>CN24</b>	<b>COM3/COM4 RS-232</b>
<b>Part Number</b>	1653004793
<b>Footprint</b>	HD_10x2P_79_23N685B-20M10
<b>Description</b>	BOX HEADER 10x2P 2.0mm 180D(M)SMD 23N685B-20M10B
<b>Pin</b>	<b>Pin Name</b>
1	DCD3#
2	DSR3#
3	RXD3
4	RTS3#
5	TXD3
6	CTS3#
7	DTR3#
8	RI3#
9	GND
10	GND
11	DCD4#
12	DSR4#
13	RXD4
14	RTS4#
15	TXD4
16	CTS4#
17	DTR4#
18	RI4#
19	GND

20	GND
----	-----

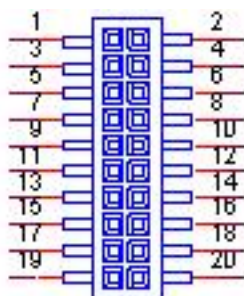

Matching Cable: 1701200220

<b>CN25</b>	<b>SMBus</b>
<b>Part Number</b>	1655904020
<b>Footprint</b>	FPC4V-125M
<b>Description</b>	WAFER 4P 1.25mm 180D(M) SMD 85205-04001
Pin	Pin Name
1	GND
2	SMB_DAT
3	SMB_CLK
4	+5V

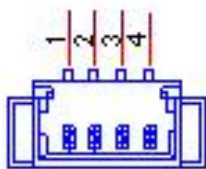

<b>CN26</b>	<b>System FAN</b>
<b>Part Number</b>	1655003010
<b>Footprint</b>	WHP3VA
<b>Description</b>	Wafer 2.54mm 3P 180D(M) DIP W/LOCK 22-27-2031
Pin	Pin Name
1	GND
2	+12V
3	Speed

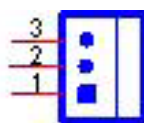

<b>CN28</b>	<b>LAN</b>
<b>Part Number</b>	1652003274
<b>Footprint</b>	RJ45_28P_RTB-19GB9J1A
<b>Description</b>	PHONE JACK RJ45 28P DIP RTB-19GB9J1A
<b>Pin</b>	<b>Pin Name</b>
1	TX+(10/100), BI_DA+(GHz)
2	TX-(10/100), BI_DA-(GHz)
3	RX+(10/100), BI_DB+(GHz)
4	BI_DC+(GHz)
5	BI_DC-(GHz)
6	RX-(10/100), BI_DB-(GHz)
7	BI_DD+(GHz)
8	BI_DD-(GHz)

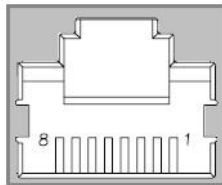

<b>CN30</b>	<b>Audio</b>
<b>Part Number</b>	1653004099
<b>Footprint</b>	HD_5x2P_79_23N685B-10M10
<b>Description</b>	BOX HEADER 5x2P 2.00mm 180D(M) SMD 23N685B-10M10
<b>Pin</b>	<b>Pin Name</b>
1	LOUTR
2	LINR
3	GND
4	GND
5	LOUTL
6	LINL
7	GND
8	GND
9	MIC1R
10	MIC1L

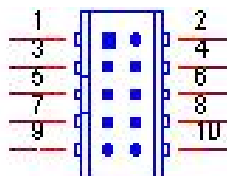

Matching Cable: 1703100152

<b>CN31</b>		<b>MIOe</b>	
<b>Part Number</b>	1654006235		
<b>Footprint</b>	BB_40x2P_32_1625x285_2HOLD		
<b>Description</b>			
Pin	Pin Name		
1	GND		
2	GND		
3	PCIE_RX0+		
4	PCIE_TX0+		
5	PCIE_RX0-		
6	PCIE_TX0-		
7	GND		
8	GND		
9	PCIE_RX1+		
10	PCIE_TX1+		
11	PCIE_RX1-		
12	PCIE_TX1-		
13	GND		
14	GND		
15	PCIE_RX2+		
16	PCIE_TX2+		
17	PCIE_RX2-		
18	PCIE_TX2-		
19	GND		
20	GND		
21	PCIE_RX3+		
22	PCIE_TX3+		
23	PCIE_RX3-		
24	PCIE_TX3-		
25	GND		
26	GND		
27	PCIE_CLK+		
28	LOUTL		
29	PCIE_CLK-		
30	LOUTR		
31	GND		
32	AGND		
33	SMB_CLK		
34	NC		
35	SMB_DAT		
36	NC		
37	PCIE_WAKE#		
38	NC		
39	RESET#		
40	NC		
41	SLP_S3#		

42	CLK33M
43	SLP_S5#
44	LPC_AD0
45	DDP_HPD
46	LPC_AD1
47	GND
48	LPC_AD2
49	DDP_AUX+
50	LPC_AD3
51	DDP_AUX-
52	LPC_DRQ#0
53	GND
54	LPC_SERIRQ
55	DDP_D0+
56	LPC_FRAME#
57	DDP_D0-
58	GND
59	GND
60	USB0_D+
61	DDP_D1+
62	USB0_D-
63	DDP_D1-
64	GND
65	GND
66	USB1_D+/USB_SSTX+
67	DDP_D2+
68	USB1_D-/USB_SSTX-
69	DDP_D2-
70	GND
71	GND
72	USB2_D+/USB_SSRX+
73	DDP_D3+
74	USB2_D-/USB_SSRX-
75	DDP_D3-
76	GND
77	GND
78	USB_OC#
79	+12VSB
80	NC
83	GND
84	GND
85	GND
86	GND
87	+5VSB
88	+5VSB
89	+5VSB
90	+5VSB

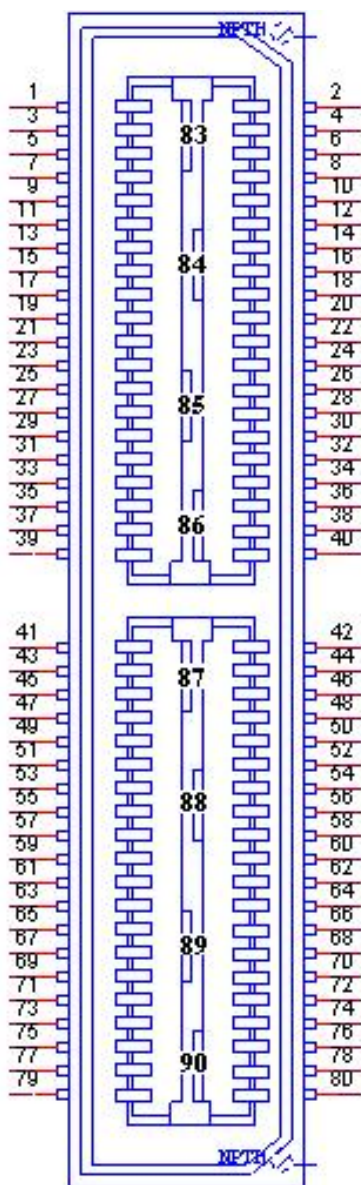

<b>CN33</b>	<b>24 bits LVDS1 Panel</b>
<b>Part Number</b>	1653910261
<b>Footprint</b>	SPH10X2
<b>Description</b>	B/B Conn 10x2P 1.25mm 180D(M)SMD DF13-20DP-1.25V
<b>Pin</b>	<b>Pin Name</b>
1	GND
2	GND
3	LVDS0_D0+
4	NC
5	LVDS0_D0-
6	NC
7	LVDS0_D1+
8	NC
9	LVDS0_D1-
10	NC
11	LVDS0_D2+

12	NC
13	LVDS0_D2-
14	NC
15	LVDS0_CLK+
16	LVDS0_D3+
17	LVDS0_CLK-
18	LVDS0_D3-
19	+5V or +3.3V
20	+5V or +3.3V

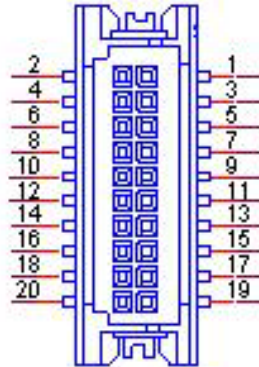

<b>CN34</b>	<b>48 bits LVDS2 Inverter Power</b>
<b>Part Number</b>	1655000453
<b>Footprint</b>	WHL5V-2M-24W1140
<b>Description</b>	WAFER BOX 2.0mm 5P 180D(M) DIP WO/Pb JIH VEI
<b>Pin</b>	<b>Pin Name</b>
1	+12V
2	GND
3	ENABKL
4	VBR
5	+5V

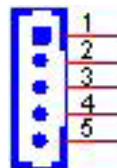



<b>CN35</b>	<b>48 bits LVDS2 Panel</b>
<b>Part Number</b>	1653920200
<b>Footprint</b>	SPH20X2
<b>Description</b>	B/B Conn. 40P 1.25mm 90D SMD DF13-40DP-1.25V(91)
<b>Pin</b>	<b>Pin Name</b>
1	+5V or +3.3V
2	+5V or +3.3V
3	GND
4	GND
5	+5V or +3.3V
6	+5V or +3.3V
7	LVDS0_D0-
8	LVDS1_D0-
9	LVDS0_D0+
10	LVDS1_D0+
11	GND
12	GND
13	LVDS0_D1-
14	LVDS1_D1-
15	LVDS0_D1+
16	LVDS1_D1+
17	GND
18	GND
19	LVDS0_D2-
20	LVDS1_D2-
21	LVDS0_D2+
22	LVDS1_D2+
23	GND
24	GND
25	LVDS0_CLK-
26	LVDS1_CLK-
27	LVDS0_CLK+
28	LVDS1_CLK+
29	GND
30	GND
31	NC
32	NC
33	GND
34	GND
35	LVDS0_D3-
36	LVDS1_D3-
37	LVDS0_D3+
38	LVDS1_D3+
39	NC
40	NC

<b>CN36</b>	<b>HDMI</b>
<b>Part Number</b>	1654009225
<b>Footprint</b>	HDMI_19P_QJ51193-FFD4-7F
<b>Description</b>	HDMI Conn 19P 0.5mm 90D(M) SMD QJ51193-FFB4-7F
<b>Pin</b>	<b>Pin Name</b>
1	TMDS Data2+
2	TMDS Data2 Shield
3	TMDS Data2@C
4	TMDS Data1+
5	TMDS Data1 Shield
6	TMDS Data1@C
7	TMDS Data0+
8	TMDS Data0 Shield
9	TMDS Data0@C
10	TMDS Clock+
11	TMDS Clock Shield
12	TMDS Clock@C
13	Reserved
14	Reserved
15	SCL
16	SDA
17	DDC Ground
18	+5V Power
19	Hot Plug Detect

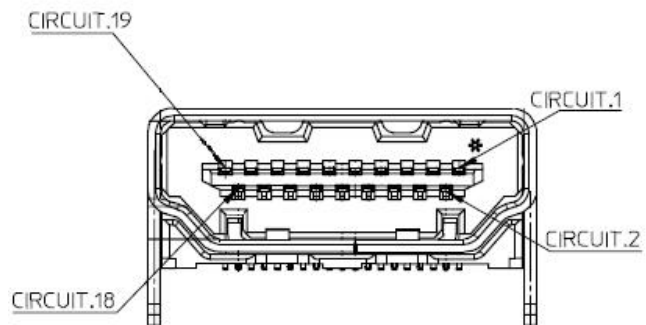

CN37	eDP
<b>Part Number</b>	1653910261
<b>Footprint</b>	SPH10X2
<b>Description</b>	B/B Conn 10x2P 1.25mm 180D(M)SMD DF13-20DP-1.25V
<b>Pin</b>	<b>Pin Name</b>
1	GND
2	GND
3	D0-
4	D3-
5	D0+
6	D3+
7	GND
8	NC
9	D1-
10	GND
11	D1+
12	SDAT
13	GND
14	SCLK
15	D2-
16	GND
17	D2+
18	Hot Plug Detect
19	+5V or +3.3V
20	+5V or +3.3V

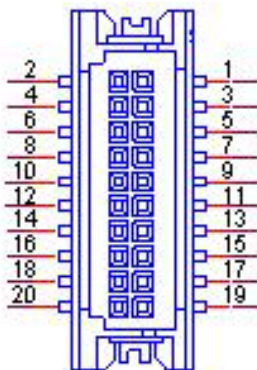

---

<b>CN38</b>	<b>24 bits LVDS1 Inverter Power</b>
<b>Part Number</b>	1655000453
<b>Footprint</b>	WHL5V-2M-24W1140
<b>Description</b>	WAFER BOX 2.0mm 5P 180D(M) DIP WO/Pb JIH VEI
<b>Pin</b>	<b>Pin Name</b>
1	+12V
2	GND
3	ENABKL
4	VBR
5	+5V



# Appendix **B**

## System Assignments

## B.1 System I/O Ports

**Table B.1: System I/O Ports**

Addr. Range (Hex)	Device
000-01F	DMA Controller
20h-2Dh	Interrupt Controller
50h-52h	Timer/Counter
060-06F	8042 (keyboard controller)
070-07F	Real-time clock, non-maskable interrupt (NMI)mask
080-09F	DMA page register
0A0-0BF	0A0-0BF
0C0-0DF	DMA controller
170h-177h	IDE Controller
1F0h-1F7h	IDE Controller
299h-29Ah	EC HM Index port and Data port
29Ch-29Dh	EC Index port and Data port
2E8-2EF	Communications Port (COM4)
2F8-2FF	Communications Port (COM2)
3E8-3EF	Communications Port (COM3)
3F8-3FF	Communications Port (COM1)
0400 - 04FF	Motherboard resources
0500 - 053F	Motherboard resources

## B.2 DMA Channel assignments

**Table B.2: DMA Channel assignments**

Channel	Function
0	Available
1	Available
2	Available
3	Available
4	Direct memory access controller
5	Available
6	Available
7	Available

## B.3 1st MB memory map

**Table B.3: 1st MB memory map**

Addr. Range (Hex)	Device
E0000h - FFFFFh	System board
D0000h - DFFFFh	PCI Bus
C0000h - CFFFFh	System board
A0000h - BFFFFh	PCI Bus
A0000h - BFFFFh	Intel® HD Graphic
00000h - 9FFFFh	System board

## B.4 Interrupt assignments

**Table B.4: Interrupt assignments**

Interrupt#	Interrupt source
NMI	Parity error detected
IRQ0	System timer
IRQ1	Standard 101/102-Key or Microsoft Natural PS/2 Keyboard
IRQ2	Interrupt from controller 2 (cascade)
IRQ3	Communications Port (COM2)
IRQ4	Communications Port (COM1)
IRQ5	EC Watch DOG
IRQ6	Available
IRQ7	Communications Port (COM3)
IRQ8	System CMOS/real time clock
IRQ9	Microsoft ACPI-Compliant System
IRQ10	Available
IRQ11	Communications Port (COM4)
IRQ12	PS/2 Compatible Mouse
IRQ13	Numeric data processor
IRQ14	Primary IDE
IRQ15	Secondary IDE





# Appendix **C**

Watchdog Timer  
Sample Code

## C.1 EC Watchdog Timer sample code

```
EC_Command_Port = 0x29Ah
EC_Data_Port = 0x299h
Write EC HW ram = 0x89
Watch dog event flag = 0x57
Watchdog reset delay time = 0x5E
Reset event = 0x04
Start WDT function = 0x28
=====
.model small
.486p
.stack 256
.data
.code
org 100h
.STARTup

mov dx, EC_Command_Port
mov al,89h      ; Write EC HW ram.
out dx,al

mov dx, EC_Command_Port
mov al, 5Fh    ; Watchdog reset delay time low byte (5Eh is high byte) index.
out dx,al

mov dx, EC_Data_Port
mov al, 30h    ;Set 3 seconds delay time.
out dx,al

mov dx, EC_Command_Port
mov al,89h    ; Write EC HW ram.
out dx,al

mov dx, EC_Command_Port
mov al, 57h    ; Watch dog event flag.
out dx,al

mov dx, EC_Data_Port
mov al, 04h    ; Reset event.
out dx,al

mov dx, EC_Command_Port
mov al,28h    ; start WDT function.
out dx,al

.exit
END
```



**ADVANTECH**

*Enabling an Intelligent Planet*

**[www.advantech.com](http://www.advantech.com)**

Please verify specifications before quoting. This guide is intended for reference purposes only.

All product specifications are subject to change without notice.

No part of this publication may be reproduced in any form or by any means, electronic, photocopying, recording or otherwise, without prior written permission of the publisher.

All brand and product names are trademarks or registered trademarks of their respective companies.

© Advantech Co., Ltd. 2013