

RECEPTACLE

PLUG

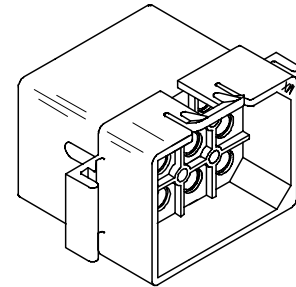
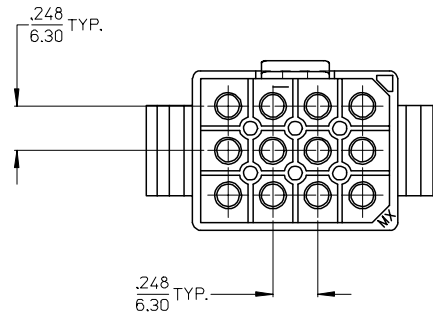
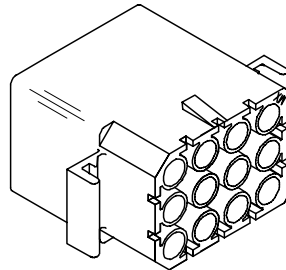
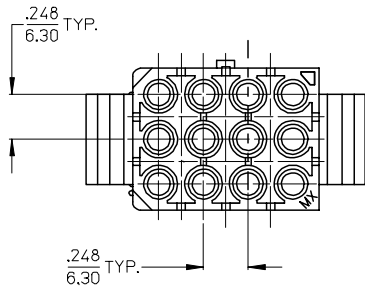
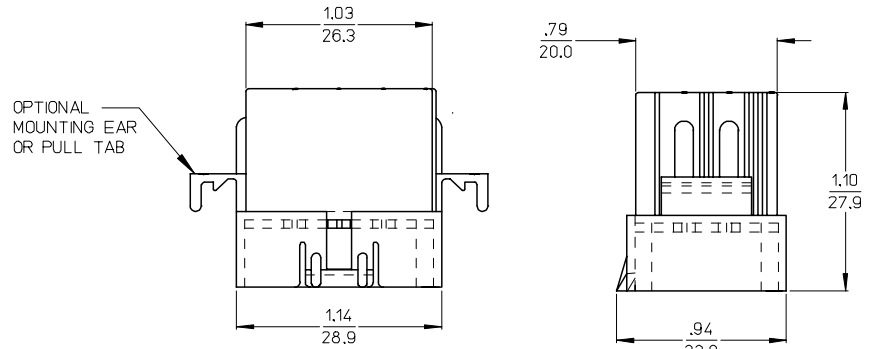
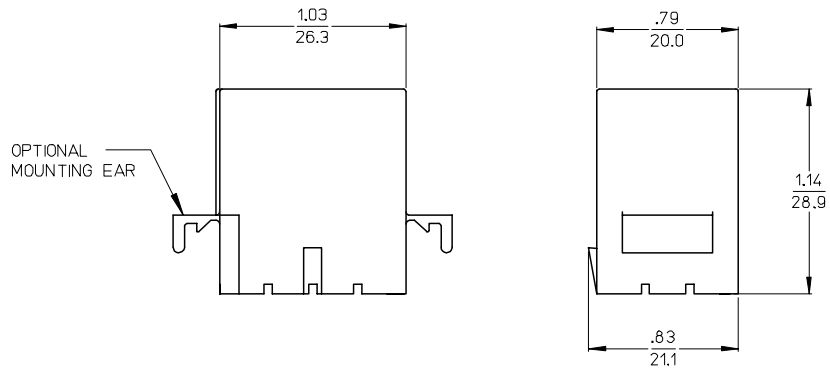
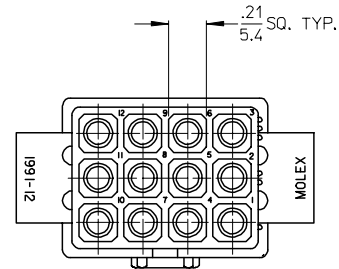
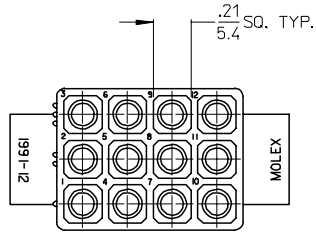

2	E
1	E
SHT., REV.	

UPDATE TITLE BLOCK FC NO: UCP2007-1498 DRWNA:ELHAG 2007/04/04 CHKD:ALHAG 2007/04/04 APPR:FSM TH 2007/04/04 REV DESCRIPTION	QUALITY SYMBOLS	GENERAL TOLERANCES (UNLESS SPECIFIED)	DIMENSION STYLE	SCALE	DESIGN UNITS	THIRD ANGLE PROJECTION
	▽=0 ▽=0	mm INCH 4 PLACES ± --- ± --- 3 PLACES ± --- ± .010 2 PLACES ± 0.25 ± .014 1 PLACE ± 0.35 ± --- ANGULAR ±1/2°	IN/MM DRAWN BY DATE KBW 1989/04/25 CHECKED BY DATE RW 1989/04/25 APPROVED BY DATE RAS 1989/04/25 MATERIAL NO. SEE CHART	2:1	INCH	TITLE .093/(2.36) HOUSINGS PLUG & RECEPTACLE 12 CKT .248/(6.30) CENTERS MOLEX INCORPORATED
	DRAFT WHERE APPLICABLE MUST REMAIN WITHIN DIMENSIONS	SIZE C	MATERIAL NO. SD-1991-12*	DOCUMENT NO.	SHEET NO.	
	THIS DRAWING CONTAINS INFORMATION THAT IS PROPRIETARY TO MOLEX INCORPORATED AND SHOULD NOT BE USED WITHOUT WRITTEN PERMISSION				1 OF 2	

13 12 11 10 9 8 7 6 5 4 3 2 1

PLUG		
ORDER NO	ENG NO	PKG. INFORMATION
I9 -09-2 I21	I991-12P	PK-1991-001
I9 -09-2 I22	I991-12P2	PK-1991-002
I9 -09-7 I21	I991-12PBK	PK-1991-001
-	-	-
-	-	-

RECEPTACLE		
ORDER NO	ENG NO	PKG. INFORMATION
I9 -09-1 I21	I991-12R2	PK-1991-001
I9 -09-1 I22	I991-12R1	PK-1991-002
I9 -09-6 I21	I991-12R2BK	PK-1991-001
I9 -09-6 I22	I991-12R1BK	PK-1991-001
-	-	-
-	-	-

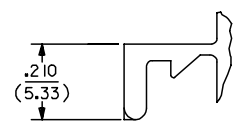

DETAIL A
STANDARD MOUNTING EAR
(SCALE 4:1)

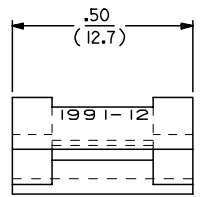

LEGEND:

I991-12****

CIRCUIT SIZE

P = PLUG
R = RECEPTACLE

BLANK = WITH PULL TABS
1 = WITHOUT EARS/WITHOUT PULL TABS
2 = WITH STANDARD EARS
3 = WITH PREBENT EARS

COLOR: _____
BLANK = NATURAL COLOR
AM = AMBER BK = BLACK BU = BLUE
BN = BROWN GY = GRAY GN = GREEN
OR = ORANGE RD = RED YW = YELLOW

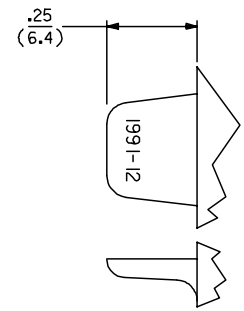
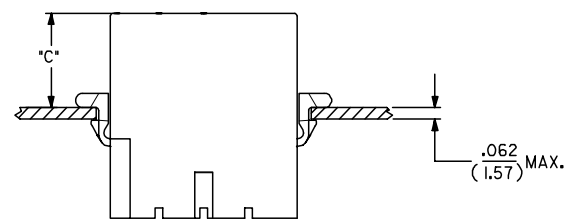

DETAIL C
PULL TAB
(SCALE 4:1)

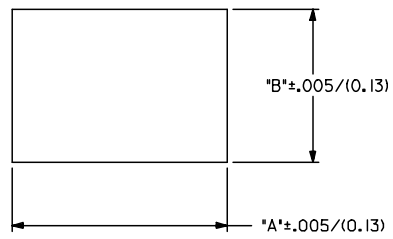

RECOMMENDED PANEL OPENING

HOUSING	DIM. "A"	DIM. "B"	"C" PREBENT EAR	"C" STANDARD EAR
PLUG	1.300/(33.02)	.910/(23.11)	.31/(7.9)	.30/(7.6)
RECEPT.	1.194/(30.33)	.850/(21.60)	.54/(13.7)	.53/(13.5)

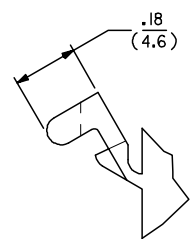

DETAIL B
PREBENT MOUNTING EAR
(SCALE 4:1)

NOTES:

1. MATERIAL: NYLON TYPE 6/6, 94V-2 PER E.S.-128A-x.
2. FINISH: N/A
3. PRODUCT SPECIFICATION: PS-02-09
4. PACKAGING INFORMATION: SEE CHART
5. HOUSINGS FOR USE WITH MOLEX STANDARD .093/(2.36) TYPE TERMINALS.
6. PARTS CONFORM TO CLASS B REQUIREMENTS OF COSMETIC SPECIFICATION PS-45499-002.

ADD NOTES 2,4 & 6 EC NO: UCP2007-1498 DRWNAELHAG 2007/04/04 CHKD: AELHAG 2007/04/04 APPR: FSM TH 2007/04/04 REVISIONS	QUALITY SYMBOLS ▽=0 ▽=0	GENERAL TOLERANCES (UNLESS SPECIFIED) mm INCH 4 PLACES ± --- ± --- 3 PLACES ± --- ± .010 2 PLACES ± 0.25 ± .014 1 PLACE ± 0.35 ± --- ANGULAR ±1/2°	DIMENSION STYLE IN/MM DRAWN BY DATE KBW 1989/04/25 CHECKED BY DATE RW 1989/04/25 APPROVED BY DATE RAS 1989/04/25	SCALE 2:1 DESIGN UNITS INCH THIRD ANGLE PROJECTION
	TITLE .093/(2.36) HOUSINGS PLUG & RECEPTACLE 12 CKT .248/(6.30) CENTERS			
	MATERIAL NO. SD-1991-12* MOLEX INCORPORATED			
	DRAFT WHERE APPLICABLE MUST REMAIN WITHIN DIMENSIONS SEE CHART			SHEET NO. 2 OF 2

12 11 10 9 8 7 6 5 4 3 2 1