



**PART No. EN4TD24428GY**

for more information visit  
[www.hamfmg.com](http://www.hamfmg.com)

Data subject to change without notice

Isometric drawing Not to Scale

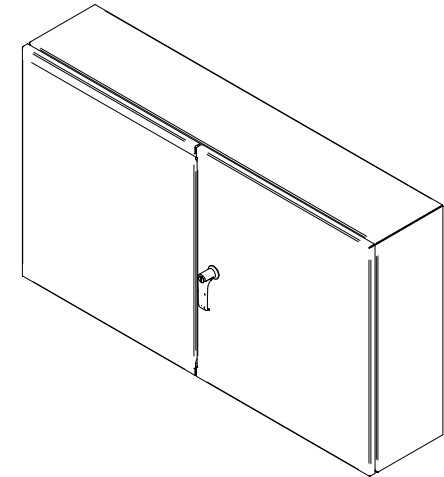

ISOMETRIC VIEW

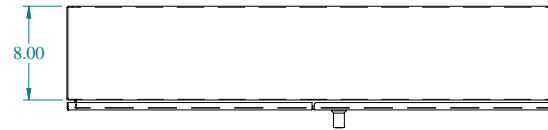

TOP VIEW

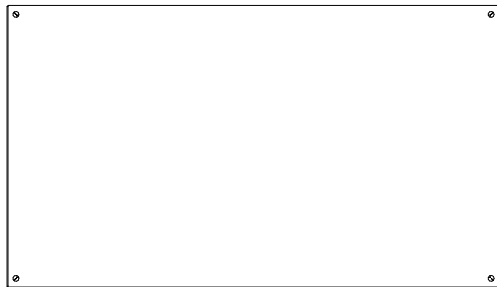

BACK VIEW

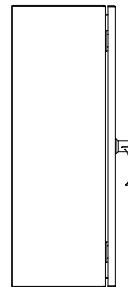

LEFT SIDE VIEW

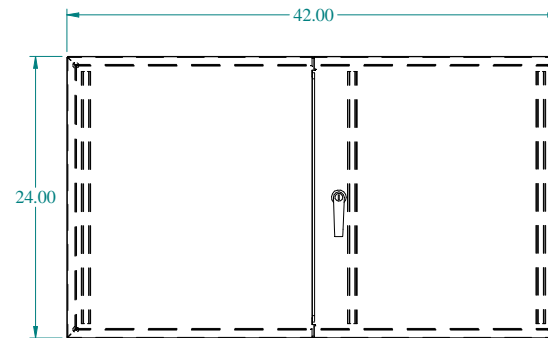

FRONT VIEW

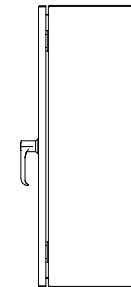

RIGHT SIDE VIEW

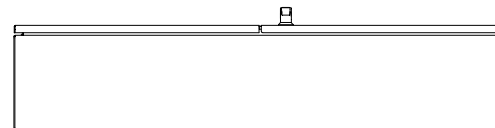

BOTTOM VIEW