

Warranty Registration
 Register online today for a chance to win a FREE Tripp Lite product!
www.tripplite.com/warranty

Owner's Manual



PowerVerter® Plus DC-to-AC Inverters

| Input | Output |
|--------|-----------------|
| 12 VDC | 120V, 60 Hz. AC |



1111 W. 35th Street, Chicago, IL 60609 USA
 Customer Support: (773) 869-1234
www.tripplite.com

* Applies to models with "UL" in their model numbers.

Reliable AC Power Wherever You Need It!

Congratulations! You've purchased the most advanced, feature-rich Inverter designed as a mobile energy source for your vehicle. PowerVerter Inverters efficiently convert DC (battery) power into 120V AC (household) power, allowing you to use equipment you commonly use at home—appliances, entertainment systems, computers, power tools and more—while cruising the open road. PowerVerter Inverters, through a high-efficiency conversion process and a charge conservation setting, draw the highest level of performance from your batteries without overtaxing them, lengthening their service life. An automatic low battery shutdown feature ensures you'll always have plenty of power for starting purposes.

- Automatic Overload Protection
- Automatic "Battery-Saver" Low Voltage Shutdown
- High Efficiency DC-to-AC Inversion
- Multi-Function Lights & Switches
- Optional Remote Control Capability
- Frequency-Controlled Output
- Moisture-Resistant Construction*
- Battery Charge Conserver (Load Sense)

Contents

| | | | |
|------------------------|----------|--|----------------------|
| Safety | 2 | Battery Connection | 7 |
| Feature Identification | 3 | AC Output Connection | 8 (back page) |
| Operation | 4 | Troubleshooting/Service/ Maintenance/Warranty | 8 (back page) |
| Application Guide | 5 | Warranty Registration | 8 (back page) |
| Mounting | 6 | | |

Regulatory Compliance Identification Numbers

For the purpose of regulatory compliance certifications and identification, your Tripp Lite product has been assigned a unique series number. The series number can be found on the product nameplate label, along with all required approval markings and information. When requesting compliance information for this product, always refer to the series number. The series number should not be confused with the marking name or model number of the product.



SAVE THESE INSTRUCTIONS!

This manual contains important instructions and warnings that should be followed during the installation, operation and storage of all Tripp Lite Inverters.

Location Warnings

- Install your Inverter in a location or compartment in your vehicle that minimizes exposure to heat, dust, direct sunlight and moisture. Flooding the unit with water will cause it to short circuit and could cause personal injury due to electric shock.
- Leave a minimum of 2" clearance at front and back of the Inverter for proper ventilation. To avoid overheating the Inverter, any compartment that contains the Inverter must be properly ventilated with adequate outside air flow. The heavier the load of connected equipment, the more heat will be generated by the unit.
- Do not install the Inverter directly near magnetic storage media, as this may result in data corruption.
- Do not install near flammable materials, fuel or chemicals.

Battery Connection Warnings

- Multiple battery systems must be comprised of batteries of identical voltage, age, amp-hour capacity and type.
- Because explosive hydrogen gas can accumulate near batteries if they are not kept well ventilated, your batteries should not be installed in a "dead air" compartment. Ideally, any compartment would have some ventilation to outside air.
- Sparks may result during final battery connection. Always observe proper polarity as batteries are connected.
- Do not allow objects to contact the DC input terminals. Do not short or bridge these terminals together. Serious personal injury or property damage could result.

Ground Connection Warnings

- Safe operation requires connecting the Inverter's Main Ground Lug directly to the frame of the vehicle or earth ground.

Equipment Connection Warnings

• Do not use a Tripp Lite Inverter in life support or healthcare applications where a malfunction or failure of a Tripp Lite Inverter could cause failure of, or significantly alter the performance of, a life support device or medical equipment.

- You may experience uneven performance results if you connect a surge suppressor, line conditioner or UPS system to the output of the Inverter.

Operation Warnings

- Your Inverter does not require routine maintenance.
- Potentially lethal voltages exist within the Inverter as long as the battery supply is connected. During any service work, the battery supply should therefore be disconnected.
- Do not connect or disconnect batteries while the Inverter is operating from the battery supply. Dangerous arcing may result.

Feature Identification

Identify the premium features on your specific model and quickly locate instructions on how to maximize their use.

- 1 Operating Mode Switch:** controls Inverter operation. Set this 2-position slide switch to “ON/REMOTE” to have your Inverter provide connected equipment with AC power by converting DC power from an attached battery or remotely monitor and control the Inverter with the use of an optional remote module. Set switch to “OFF” when not using connected equipment to prevent battery drain.
 - 2 “LOAD” Indicator Lights:** intuitive “traffic light” signals show approximate equipment load level. See page 4 for instructions on reading indicator lights.
 - 3 “BATTERY” Indicator Lights:** intuitive “traffic light” signals show approximate charge level of your battery. See page 4 for instructions on reading indicator lights.
 - 4 DC Power Terminals:** connect to your battery terminals. See page 7 for connection instructions.
 - 5 Ground Fault Interrupter (GFI) AC Receptacles:** allow you to connect equipment that would normally be plugged into a utility outlet. They feature ground fault interrupter switches that trip if there is excessive current on the ground safety wire.
 - 6 Resettable Circuit Breaker:** protects your Inverter against damage due to overload. See page 4 for resetting instructions.
 - 7 Remote Control Module Connector:** allows remote monitoring and control with an optional module (Tripp Lite model APSRM4, sold separately). See remote module owner’s manual for connection instructions.
 - 8 Battery Charge Conserver (Load Sense) Dial:** conserves battery power by setting the low-load level at which the Inverter automatically shuts off. See page 4 for setting instructions.
 - 9 Multi-Speed Cooling Fan(s):** quiet, efficient fans prolong equipment service life.
 - 10 Main Ground Lug:** properly grounds the Inverter to vehicle grounding system or earth ground. See page 7 for connection instructions.
- Low Battery Alarm/Shutdown (internal, not shown):** automatically detects low voltage and shuts down Inverter to preserve vehicle battery.
- Overload Alarm/Shutdown (internal, not shown):** automatically detects wattage overload on Inverter outlets and shuts down Inverter as a protective measure.
- Ignition Switch Control Jack (rear panel, not shown):** use to connect the Inverter to your vehicle’s ignition switch (with user-supplied cable) in order to automatically control the Inverter with the vehicle's ignition switch. See Operation section.

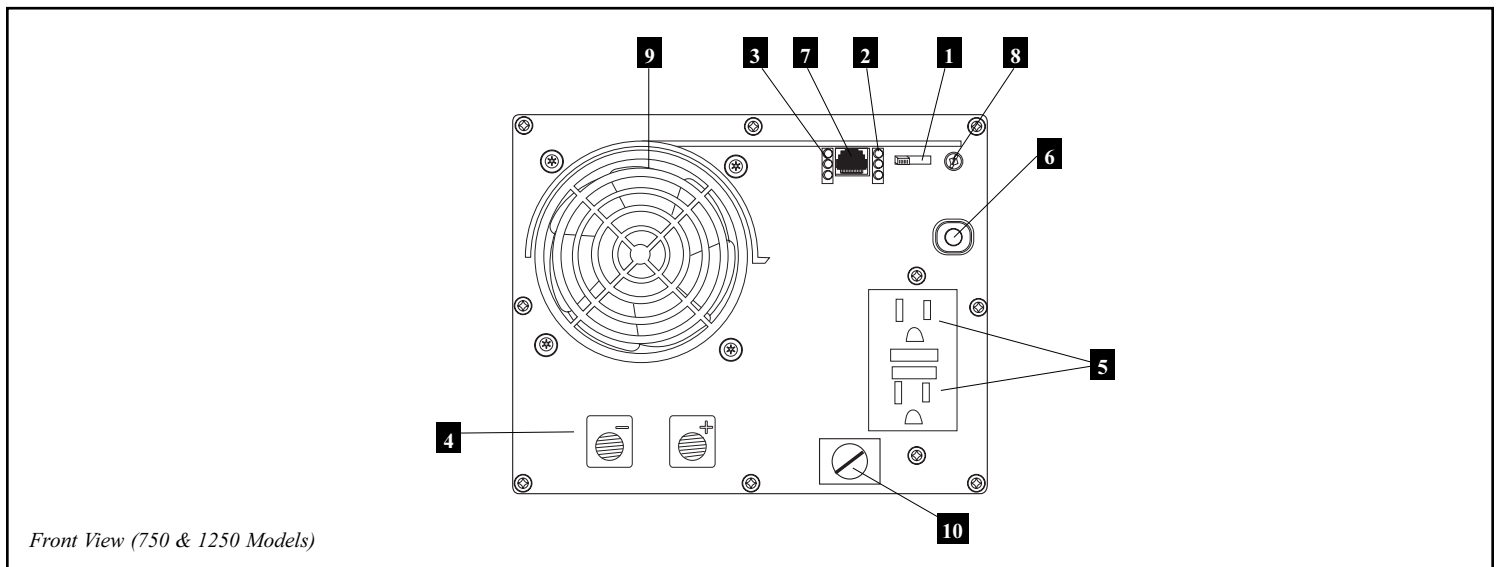

Operation

Switch Modes

Switch between the following operating modes as appropriate to your situation:

“ON/REMOTE”: Switch to this setting to provide connected equipment with AC power. Also, switch to this setting to remotely monitor and control the Inverter with the use of an optional remote module. See remote module’s owner’s manual for operating instructions.

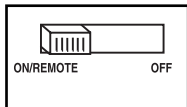

“OFF”: Switch to this setting to shut down the Inverter completely, preventing it from drawing power from the batteries. Use this switch to automatically reset the unit if it shuts down due to low battery or overload. Use an optional remote control module (Tripp Lite model APSRM4, sold separately) to reset unit due to overload only.

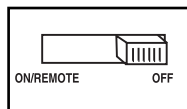

Indicator Lights

Your Inverter is equipped with a simple, intuitive, user-friendly set of indicator lights. These easily-remembered “traffic light” signals will allow you, shortly after first use, to tell at a glance the charge condition of your batteries, as well as ascertain approximate equipment load level.

“BATTERY” Indicator Lights: These three lights will illuminate in several sequences to show the approximate charge level of your connected battery:

Approximate Battery Charge Level[†]

| Indicator Illuminated | Battery Capacity |
|----------------------------|----------------------------|
| 1 Green | 91%–Full |
| 2 Green & Yellow | 81%–90% |
| 3 Yellow | 61%–80% |
| 4 Yellow & Red | 41%–60% |
| 5 Red | 21%–40% |
| 6 Flashing Red (slowly)* | 1%–20% |
| 7 Flashing Red (quickly)** | 0% (Inverter has shutdown) |

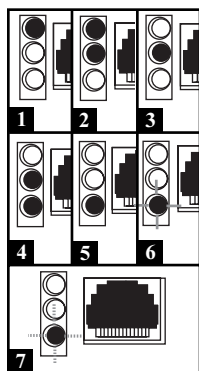

“LOAD” Indicator Lights: These three lights will illuminate in several sequences to show the approximate equipment load level on the Inverter’s AC receptacles.

Approximate Equipment Load Level

| Indicator Illuminated | Load Level |
|----------------------------|----------------------------------|
| 1 Green | 0%–50% |
| 2 Green & Yellow | 51%–75% |
| 3 Yellow | 76%–90% |
| 4 Red | ≥ 90% |
| 5 Flashing Red (quickly)** | OVERLOAD (Inverter has shutdown) |

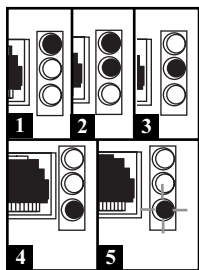

[†] Charge levels listed are approximate. Actual conditions vary depending on battery condition and load. * Approximately ½ second on, ½ second off. ** Approximately ¼ second on, ¼ second off. See “Resetting Your Inverter to Restore AC Power” to reset after Inverter shut down.

Resetting Your Inverter to Restore AC Power

Your Inverter may cease supplying AC power in order to protect itself from overload or to protect your electrical system. To restore normal functioning:

Low Battery Shutdown Reset: Set operating mode switch to “OFF” and run vehicle engine to recharge battery. When battery is adequately charged, switch operating mode switch back to “ON/REMOTE.”

Overload Shutdown Reset: Set operating mode switch to “OFF” and remove some of the connected electrical load (ie: turn off some of the AC devices drawing power which may have caused the overload of the unit). Wait one minute, then switch operating mode switch back to “ON/REMOTE.”

Output Circuit Breaker Reset (Select Models): Alternatively, check output circuit breaker on the unit’s front panel. If tripped, remove some of the electrical load, then wait one minute to allow components to cool before resetting the circuit breaker. See Troubleshooting for other possible reasons AC output may be absent.

Set Battery Charge Conserver (Load Sense) Dial
In order to save battery power, the Inverter automatically shuts off in the absence of any power demand from connected equipment or appliances (the electrical load). When the unit detects a load, it automatically turns on. Users may choose the minimum load the Inverter will detect by adjusting the Battery Charge Conserver Dial (see diagram). Using a small tool, turn the dial clockwise to lower the minimum load that will be detected, causing the Inverter to turn on for smaller loads. When the dial is turned fully clockwise, the Inverter will operate even when there is no load. Turn the dial counterclockwise to set a higher minimum load, causing the Inverter to stay off until the new minimum load is reached. When the dial is turned fully counterclockwise, the Inverter will turn on when it detects any load greater than approximately 150 Watts.

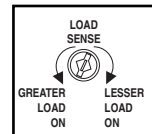

Note: The factory setting for the dial is fully clockwise. However, based on the threshold load to which you’d like the Inverter to respond, you should adjust the dial counterclockwise to reduce its sensitivity until the Inverter is active only when connected equipment or appliances are actually in use.

Connect Remote Control—OPTIONAL

All models feature an 8-conductor telephone style receptacle on the front panel for use with an optional remote control module (Tripp Lite model APSRM4, sold separately.) The remote module allows the Inverter to be mounted in a compartment or cabinet out of sight, while operated conveniently from your vehicle’s dashboard. See instructions packed with the remote control module.

Connect Ignition Switch Control Jack—OPTIONAL

All models feature a jack which can be used to connect the Inverter to your vehicle’s ignition switch in order to automatically control the Inverter. This connection is optional; the Inverter will function without this connection.

WARNING! THE IGNITION SWITCH CONTROL FUNCTION IS ONLY FOR USE WITH 12V NEGATIVE GROUND SYSTEMS.

Wiring the Ignition Switch Control Cable to your vehicle’s ignition requires a qualified technician, who must determine the proper wiring procedure.

When connected to the vehicle’s ignition switch, this function automatically disables (turns OFF) the AC power output from the Inverter when the vehicle’s ignition switch is placed in the “Engine Run” position. This function will satisfy local codes and requirements concerning video monitors (or TVs) that are located within a driver’s view by automatically turning them off when the engine is started. Tripp Lite makes a current-limited cable assembly (part # 73-0977) for this purpose. Connect the current-limited cable’s red wire to the ignition switch’s “Engine Run” terminal. The cable’s black wire can be left unterminated. Then, connect the current-limited cable’s mini-plug to the Ignition Switch Control Jack located on the Inverter’s rear panel. After connecting the interface cable, set the Inverter’s switch to “ON/REMOTE”. The current-limited cable’s mini-plug should remain in the Inverter’s Ignition Switch Control Jack whenever the ignition is on to avoid shorting the battery.



Application Guide

Match Battery Amp-Hour Capacity to Your Application



Select a battery or system of batteries that will provide your Inverter with proper DC voltage and an adequate amp-hour capacity to power your application. Even though Tripp Lite Inverters are highly efficient at DC-to-AC inversion, their rated output capacities are limited by the total amp-hour capacity of connected batteries and the support of your vehicle's alternator if the engine is kept running.

Example

Tools

| | | | | |
|--|---|--|---|---------------|
|  1/4" Drill |  Orbital Sander |  Cordless Tool Charger | | |
| 300W | + | 220W | + | 20W |
| | | | | = 540W |

Appliances

| | | | | |
|---|---|--|---|---------------|
|  Blender |  Color TV |  Laptop Computer | | |
| 300W | + | 140W | + | 100W |
| | | | | = 540W |

- **STEP 1: Determine Total Wattage Required**

Add the wattage ratings of all equipment you will connect to your Inverter. Wattage ratings are usually listed in equipment manuals or on nameplates. If your equipment is rated in amps, multiply that number times AC utility voltage to determine watts. (Example: a 1/4 in. drill requires 2 1/2 amps. 2 1/2 amps × 120 volts = 300 watts.)

Note: Your Inverter will operate at higher efficiencies at about 75% - 80% of nameplate rating.

- **STEP 2: Determine DC Battery Amps Required**

Divide the total wattage required (from step 1, above) by the battery voltage (12) to determine the DC amps required.

$$540 \text{ watts} \div 12V = \mathbf{45 \text{ DC Amps}}$$

- **STEP 3: Estimate Battery Amp-Hours Required** (for operation unsupported by the alternator)

Multiply the DC amps required (from step 2, above) by the number of hours you estimate you will operate your equipment exclusively from battery power before you have to recharge your batteries. Compensate for inefficiency and wiring losses by multiplying this number by 1.2. This will give you a rough estimate of how many amp-hours of battery power (from one or several batteries) you should connect to your Inverter.

NOTE: Battery amp-hour ratings are usually given for a 20-hour discharge rate. Actual amp-hour capacities are less when batteries are discharged at faster rates. For example, batteries discharged in 55 minutes provide only 50% of their listed amp-hour ratings, while batteries discharged in 9 minutes provide as little as 30% of their amp-hour ratings.

$$45 \text{ DC Amps} \times 5 \text{ Hrs. Runtime} \\ \times 1.2 = \mathbf{270 \text{ Amp-Hours}}$$

You must allow your batteries to recharge long enough to replace the charge lost during Inverter operation or else you will eventually run down your batteries.

NOTE: For Tripp Lite Inverters over 1000 watts used in mobile applications, Tripp Lite recommends you use at least two batteries, if possible, fed by a heavy-duty alternator anytime the vehicle is running. Tripp Lite Inverters will provide adequate power for ordinary usage within limited times without the assistance of your vehicle's alternator. However, when operating extremely heavy electrical loads at their peak, you may wish to "assist your batteries" by running your vehicle engine faster than normal idling.

Mounting *optional*



WARNING! If you choose to mount your Inverter, mount it and wire its DC input **BEFORE** DC battery connection. Failure to follow these instructions may lead to personal injury and/or damage to the Inverter and connected systems.

Tripp Lite Inverters are designed for horizontal mounting in a variety of vehicular or non-vehicular applications. User must supply mounting hardware and is responsible for determining if the hardware and mounting surface are suitable to support the weight of the Inverter. Contact Tripp Lite if you require further assistance in mounting your Inverter.

Vehicular and Non-Vehicular Horizontal Mount

A Using the measurements from the diagram, install two user-supplied $\frac{1}{4}$ " (6 mm) fasteners into a rigid horizontal surface, leaving the heads slightly raised. **B** Slide the Inverter/Charger back over the fasteners to engage the mounting slots molded on the bottom of the Inverter/Charger cabinet. **C** Install and tighten two user-supplied $\frac{1}{4}$ " (6 mm) fasteners into the mounting feet molded on the front of the Inverter/Charger cabinet.

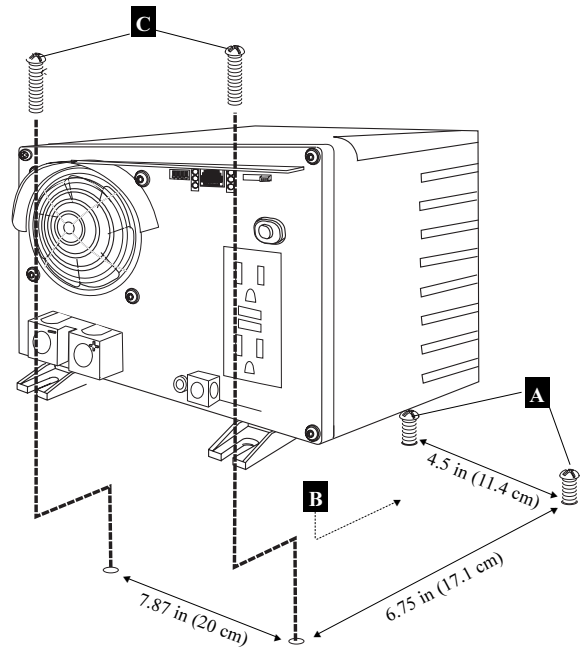

Battery Connection

Connect your Inverter to your batteries using the following procedures—always loosely twist each pair of cables together before connecting them separately to the appropriate DC terminal on the Inverter (positive or negative).

• Connect DC Wiring:

You must run positive cable(s) through user-supplied UL-listed fuse(s) and fuse block(s) of the proper size.

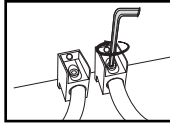

See Specifications page for Minimum Recommended Cable Sizing Chart. An excellent source of cables is battery jumper cables. Output performance will decrease if you use only one jumper cable.

Although your Inverter is a high-efficiency converter of electricity, its rated output capacity is limited by the length and gauge of the cabling running from the battery to the unit. Use the shortest length and largest diameter cabling (maximum 00 gauge) to fit your Inverter's DC Input terminals. Shorter and heavier gauge cabling reduces DC volt-

age drop and allows for maximum transfer of current. Your Inverter is capable of delivering peak wattage at up to 200% of its rated continuous wattage output instantaneously. See Specifications page for details. Heavier gauge cabling should be used when continuously operating heavy draw equipment under these conditions. Tighten your Inverter and battery terminals to approximately 3.5 Newton-meters (2.58 foot lbs.) of torque to create an efficient connection and to prevent excessive heating at this connection. Insufficient tightening of the terminals could void your warranty.

• **Connect Ground:** Using a #8 AWG wire or larger, directly connect the Main Ground Lug to the vehicle's chassis ground or earth ground. See Feature Identification section to locate Main Ground Lug. All installations must comply with national and local codes and ordinances.

• **Connect Fuse:** In addition to the protection provided by the Inverter's internal fuses, NEC article 551 requires that you connect your Inverter's positive DC Terminal(s) directly to a UL-listed fuse(s) and fuse block(s) within 18 inches of the battery. See diagrams below for proper fuse placement.



WARNING! Never attempt to operate your Inverter by connecting it directly to output from an alternator rather than a battery or battery bank.

CAUTION! Observe proper polarity with all DC connections.

Vehicular

Your Inverter's Nominal DC Input Voltage **must match** the voltage of your battery or batteries—12 Volts in most vehicular applications. It is possible to connect your Inverter to the main battery within your vehicle's electrical system. In many vehicular contexts, the Inverter will be connected to one or more dedicated auxiliary (house) batteries which are isolated from the drive system to prevent possible draining of the main battery.

- 1 12 Volt Alternator
- 2 Vehicle Battery Ground
- 3 12 Volt Main Battery
- 4 12 Volt Auxiliary (House) Battery
- 5 UL-Listed Fuses & Fuse Blocks (mounted within 18 inches of the battery)
- 6 Battery Isolator
- 7 Large Diameter Cabling, Maximum 00 Gauge to Fit Terminals
- 8 8 AWG (minimum) Ground Wire to Vehicle Frame or Earth Ground

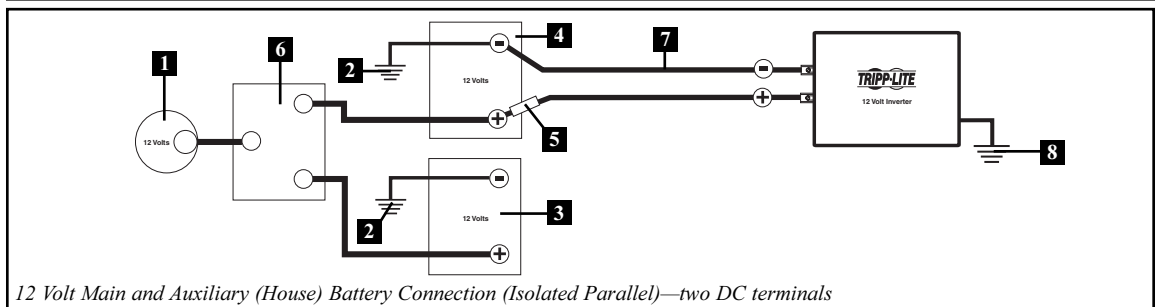
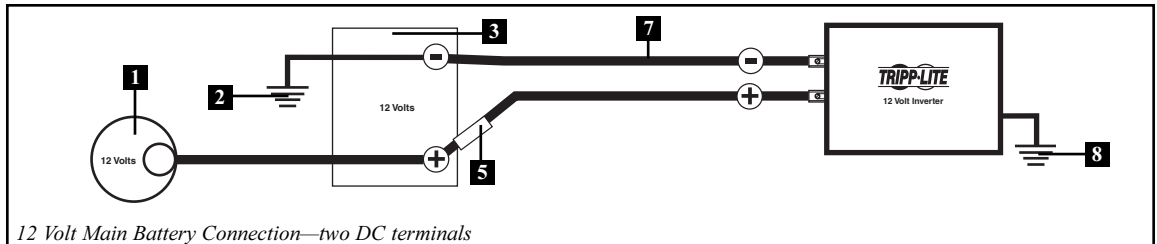

AC Output Connection

To avoid overloading your Inverter, be sure to match the power requirements of the equipment you plan to run at any one time (add their total watts) with the output wattage capacity of your Inverter model (see Specifications). When figuring the power requirements of your equipment, do not confuse “continuous” wattage with “peak” wattage ratings. Most electric motors require extra power at start-up (“peak” wattage) than required to run continuously after start-up, sometimes over 100% more. Some motors, such as in refrigerators and pumps, start and stop intermittently according to demand, requiring “peak” wattage at multiple, unpredictable times during operation.

• DoubleBoost™ Feature

Tripp Lite Inverters deliver up to twice their nameplate rated wattage for up to 10 seconds,* providing the extra power needed to cold start heavy-duty tools and equipment.

• OverPower™ Feature

Tripp Lite Inverters deliver up to 150% of their nameplate rated wattage for up to 1 hour,* providing plenty of reserve power to reliably support tools and equipment longer.

** Actual duration depends on battery age, battery charge level and ambient temperature.*

Troubleshooting

Try these remedies for common Inverter problems before calling for assistance. Call Tripp Lite Customer Service at (773) 869-1234 before returning your unit for service.

Operating Mode Switch

Battery Indicator Lights

Load Indicator Lights

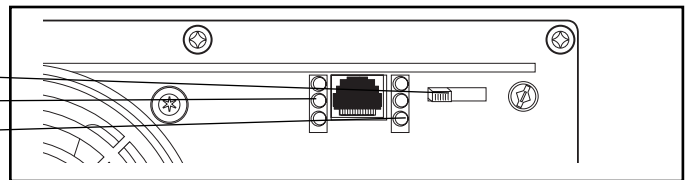

| SYMPTOM | PROBLEMS | CORRECTIONS |
|---|---|--|
| No AC Output (All Indicator Lights Are OFF) | Operating Mode Switch is set to “OFF.” | Set Operating Mode Switch to “ON/REMOTE.” |
| | User-supplied UL-listed external DC input fuses have blown. | Replace fuses. |
| Red Battery Indicator Light Is Rapidly Flashing (¼ Second Flashes) | Unit has shut down due to excessive battery discharge. | Run your engine to raise battery voltage. Check external battery connections and fuse. Reset by moving Operating Mode Switch to “OFF.” Wait one minute and switch to “ON/REMOTE.” If unit remains in shutdown mode after several attempts to reset contact Tripp Lite Customer Service for assistance. |
| Red Load Indicator Light Is Rapidly Flashing (¼ Second Flashes) | Unit has shut down due to overload. | Reduce load. Reset by moving Operating Mode Switch to “OFF.” Wait one minute and switch to “ON/REMOTE.” If unit remains in shutdown mode after several attempts to reset contact Tripp Lite Customer Service for assistance. |
| Connected Equipment Experiences Buzzing Sound Or Picture Distortion | Audio/Video interference. | Reposition equipment antennas and Inverter. |
| Inverter Output Seems Intermittent | Loose cable connections. | Check and secure all connections. |

Service

If you are returning your Inverter to Tripp Lite, please pack it carefully, using the ORIGINAL PACKING MATERIAL that came with the unit. Enclose a letter describing the symptoms of the problem. If the Inverter is within the warranty period, enclose a copy of your sales receipt. To obtain service you must obtain a Returned Material Authorization (RMA) number from Tripp Lite or an authorized Tripp Lite service center.

Maintenance

Your Inverter requires no maintenance and contains no user-serviceable or replaceable parts, but should be kept dry at all times. Periodically check, clean and tighten all cable connections, as necessary, both at the unit and at the battery.

Limited Warranty

Tripp Lite warrants its Inverters to be free from defects in materials and workmanship for a period of one year (domestic) or 120 days (export) from the date of retail purchase by end user.

Tripp Lite's obligation under this warranty is limited to repairing or replacing (at its sole option) any such defective products. To obtain service under this warranty you must obtain a Returned Material Authorization (RMA) number from Tripp Lite or an authorized Tripp Lite service center. Products must be returned to Tripp Lite or an authorized Tripp Lite service center with transportation charges prepaid and must be accompanied by a brief description of the problem encountered and proof of date and place of purchase. This warranty does not apply to equipment which has been damaged by accident, negligence or misapplication or has been altered or modified in any way, including opening of the unit's casing for any reason. This warranty applies only to the original purchaser who must have properly registered the product within 10 days of retail purchase.

EXCEPT AS PROVIDED HEREIN, TRIPP LITE MAKES NO WARRANTIES, EXPRESS OR IMPLIED, INCLUDING WARRANTIES OF MERCHANTABILITY AND FITNESS FOR A PARTICULAR PURPOSE. Some states do not permit limitation or exclusion of implied warranties; therefore, the aforesaid limitation(s) or exclusion(s) may not apply to the purchaser.

EXCEPT AS PROVIDED ABOVE, IN NO EVENT WILL TRIPP LITE BE LIABLE FOR DIRECT, INDIRECT, SPECIAL, INCIDENTAL OR CONSEQUENTIAL DAMAGES ARISING OUT OF THE USE OF THIS PRODUCT, EVEN IF ADVISED OF THE POSSIBILITY OF SUCH DAMAGE. Specifically, Tripp Lite is not liable for any costs, such as lost profits or revenue, loss of equipment, loss of use of equipment, loss of software, loss of data, costs of substitutes, claims by third parties, or otherwise.

Tripp Lite has a policy of continuous improvement. Specifications are subject to change without notice.

Warranty Registration

Visit www.tripplite.com/warranty to register the warranty of your new Tripp Lite product. You'll be automatically entered into a drawing for a chance to win a FREE Tripp Lite product!*

** No purchase necessary. Void where prohibited. Some restrictions apply. See website for details.*

This product designed and engineered in the USA.