

PRODUCT NO.
10123371-001LF
10123371-001TRLF

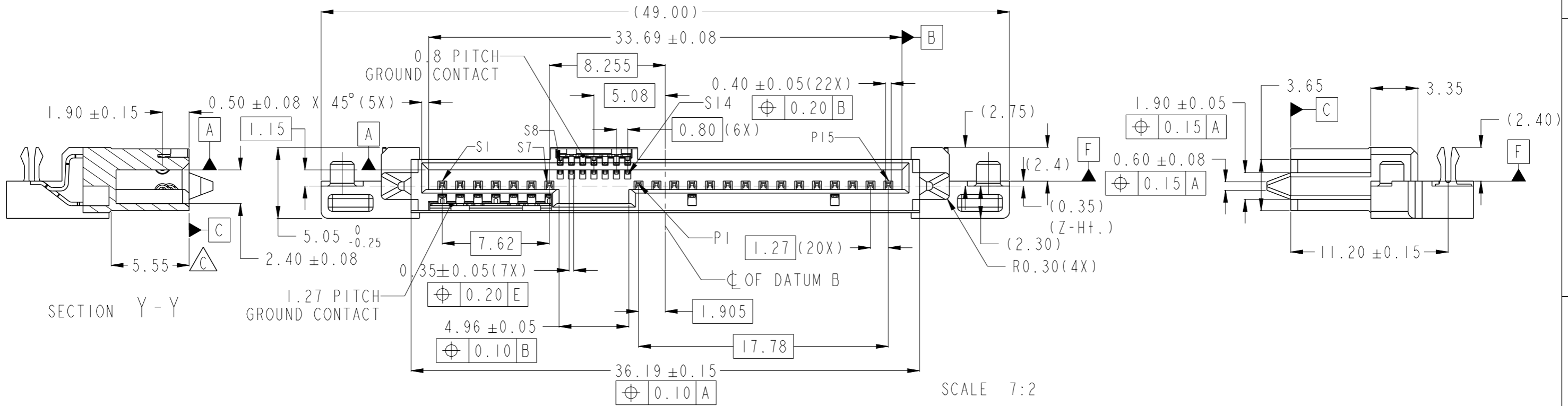
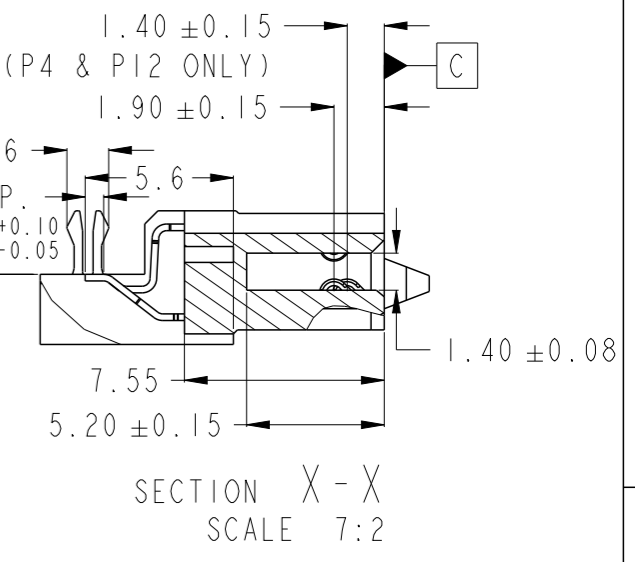
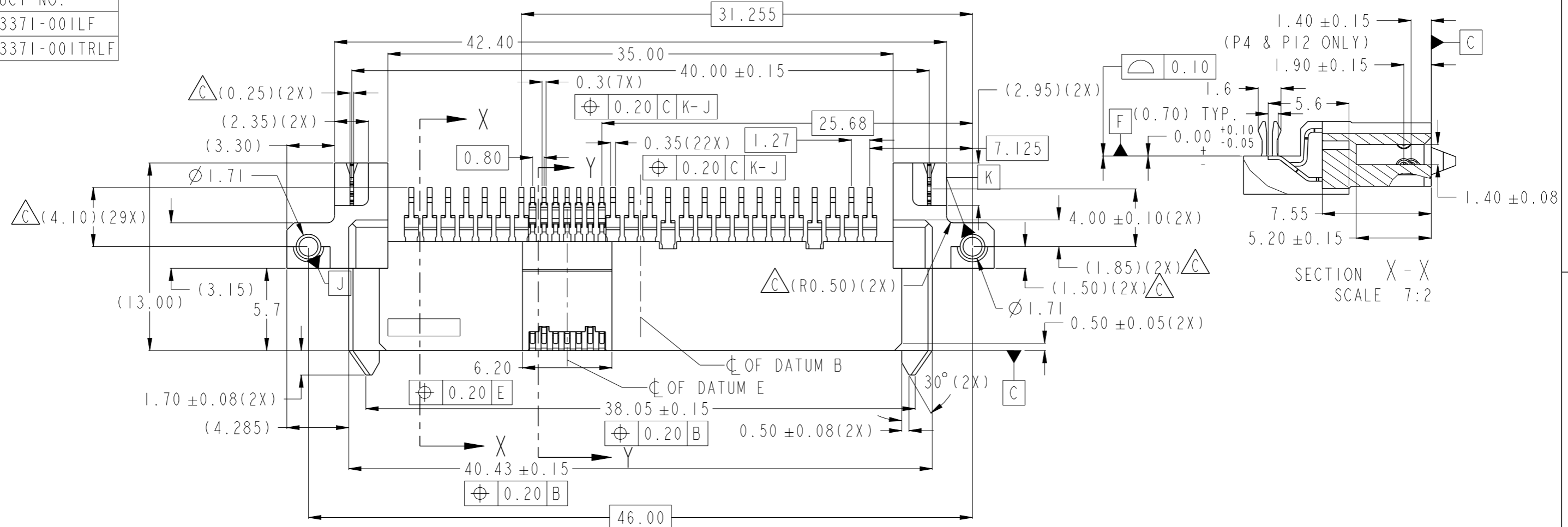

Amphenol FCI

© 2016 AFCI

spec ref	-	dr	Jeffrey Lim	2014/12/17	projection	MM	size	A3	scale	7:2							
tolerance std	TOLERANCES UNLESS OTHERWISE SPECIFIED	eng	Jeffrey Lim	2018/07/31			ecn no	ELX-S-30826-1	rel level	Released							
surface	<table border="1"> <tr> <td>linear</td> <td>0.X</td> <td>±</td> </tr> <tr> <td></td> <td>0.XX</td> <td>±0.20</td> </tr> <tr> <td></td> <td>0.XXX</td> <td>±</td> </tr> <tr> <td>angular</td> <td>0°</td> <td>±2°</td> </tr> </table>	linear	0.X	±				0.XX		±0.20		0.XXX	±	angular	0°	±2°	chr
linear	0.X	±															
	0.XX	±0.20															
	0.XXX	±															
angular	0°	±2°															
		appr	Koon-Poh Tay	2018/08/15			dwg no	10123371	rev	C							
					cat. no.		Product - Customer Drw		sheet 1 of 3								

PRODUCT NO.
10123371-002LF
10123371-002TRLF

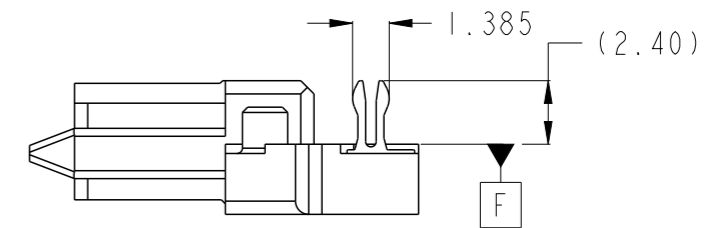
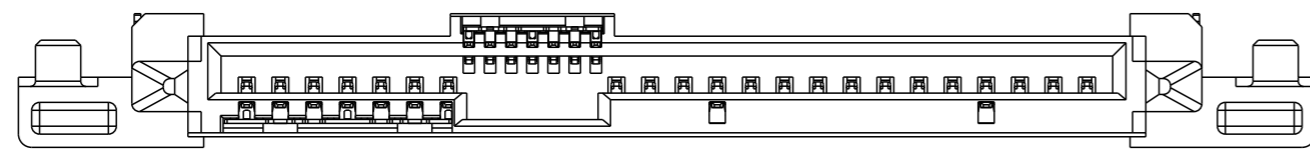
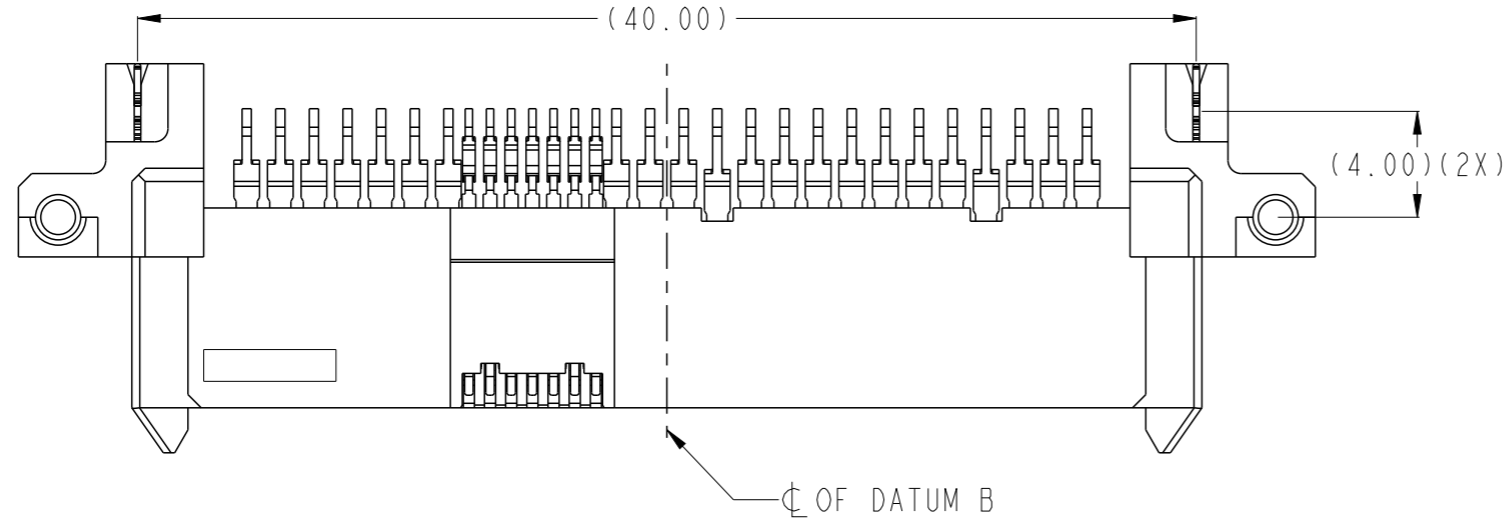

SCALE 7:2

FOR MORE DIMENSIONS, REFER TO -001LF

spec ref	-			dr	Jeffrey Lim	2014/12/17	projection	MM	size	A3	scale	1:1
tolerance std	TOLERANCES UNLESS OTHERWISE SPECIFIED			eng	Jeffrey Lim	2018/07/31		← →	ecn no	ELX-S-30826-1		
-				chr	-	-			product family	rel level	Released	
surface	✓	linear	0.X ± - 0.XX ±0.20 0.XXX ± -	Amphenol FCi	12G SAS RECEPTACLE			dwg no	10123371			rev C
-		angular	0° ±2°		R/A ASSY, Z-HT. 0.35				cat. no.	Product - Customer Drw		

PRODUCT NO.	PACKAGING
10123371-001LF	TRAY
10123371-002LF	
10123371-001TRLF	TAPE & REEL
10123371-002TRLF	

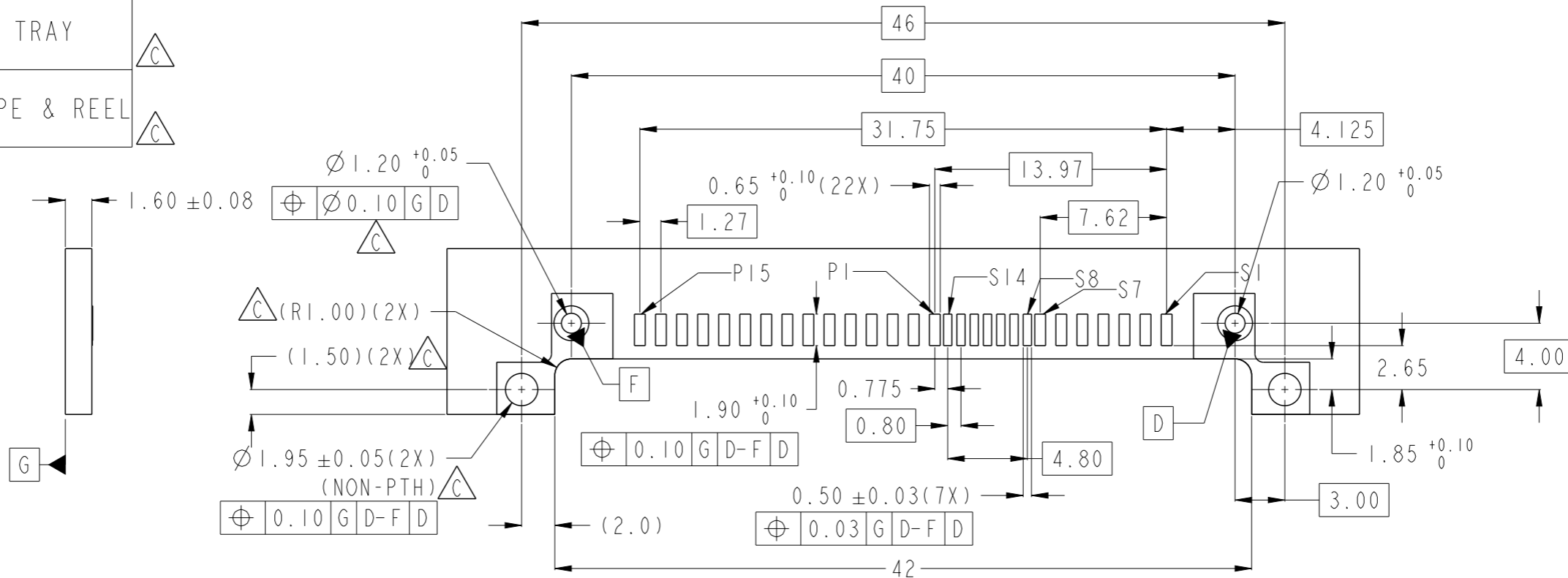

SCALE 3:1
 RECOMMENDED PCB LAYOUT
 (GENERAL TOLERANCE: ± 0.05)

- NOTES:
- MATERIALS:
 - HOUSING: HIGH TEMP THERMOPLASTIC, UL 94V-0, COLOUR: BLACK
 - TERMINAL, FORK-LOCK CLIP AND GROUND CONTACT: COPPER ALLOY
 - FINISH:
 - TERMINAL: 30u" MIN Au PLATING (CONTACT POINT) OVER 50u" MIN NICKEL
 - SOLDER TAIL: 100u" MIN TIN OVER 50u" MIN NICKEL
 - FORK-LOCK CLIP: 100u" MIN TIN OVER 50u" MIN NICKEL
 - PRODUCT SPECIFICATION : GS-12-1120
 - PACKAGING SPECIFICATION: GS-14-841(TRAY); GS-14-966(TAPE & REEL)
 - THIS PRODUCT IS COMPLY WITH SFF-8680 SPECIFICATION
 - THIS PRODUCT MEETS EUROPEAN UNION DIRECTIVES AND OTHER COUNTRY REGULATIONS AS DESCRIBED IN GS-47-0004
 - THE HOUSING WILL WITHSTAND EXPOSURE TO 260° PEAK TEMPERATURE FOR 10 SECONDS IN A CONVECTION, INFRA-RED OR VAPOR PHASE REFLOW OVEN
 - A SYMBOL $\triangle C$ WILL BE NEXT TO ANY DIMENSION, VIEW, OR NOTE WHICH HAS BEEN MODIFIED WITH THE CURRENT DRAWING REVISION

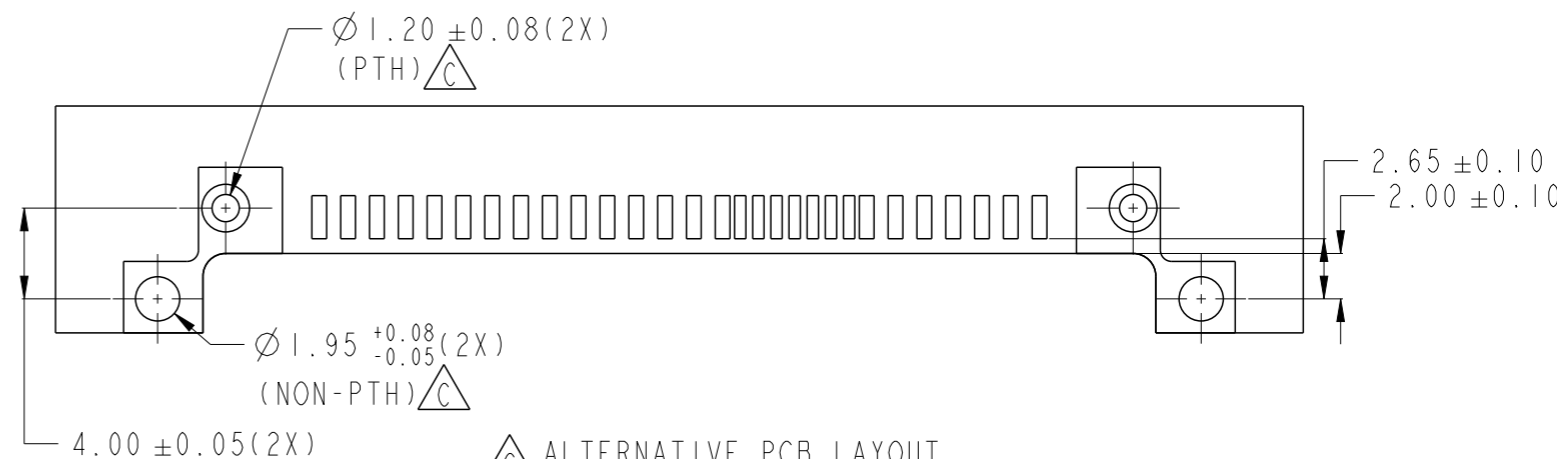

$\triangle C$ ALTERNATIVE PCB LAYOUT
 (REFER TO RECOMMENDED PCB LAYOUT FOR UNSPECIFIED DIMENSIONS)

SCALE 3:1

spec ref	-	dr	Jeffrey Lim	2014/12/17	projection	MM	size	A3	scale	1:1	
tolerance std	TOLERANCES UNLESS OTHERWISE SPECIFIED	eng	Jeffrey Lim	2018/07/31		← →	ecn no	ELX-S-30826-1	rel level	Released	
-	-	chr	-	-			product family	-			
surface	linear	0.X	± -	Amphenol FCI	12G SAS RECEPTACLE		dwg no	10123371		rev	C
-	0.XX	± 0.20	R/A ASSY, Z-HT. 0.35		cat. no.	-		Product - Customer Drw	sheet 3 of 3		
-	angular	0°	± 2°		PDS: Rev :C		STATUS:Released		Printed: Aug 15, 2018		