

## 0.3W, PNP Plastic-Encapsulate Transistor

### FEATURES

- Low power loss, high efficiency
- Ideal for automated placement
- High surge current capability
- Compliant to RoHS directive 2011/65/EU and in accordance to WEEE 2002/96/EC
- Halogen-free according to IEC 61249-2-21

### APPLICATIONS

- Switching mode power supply (SMPS)
- Adapters
- Lighting application
- On-board DC/DC converter

### MECHANICAL DATA

- Case: SOT-23
- Molding compound meets UL 94 V-0 flammability rating
- Moisture sensitivity level: level 1, per J-STD-020
- Packing code with suffix "G" means green compound (halogen-free)
- Terminal: Matte tin plated leads, solderable per J-STD-002
- Meet JESD 201 class 1A whisker test
- Weight: 0.008grams (approximately)

KEY PARAMETERS		
PARAMETER	VALUE	UNIT
$V_{CBO}$	-50	V
$V_{CEO}$	-45	V
$V_{EBO}$	-5	V
$I_C$	-0.5	A
$h_{FE}$	250-600	
Package	SOT-23	
Configuration	Single Dice	

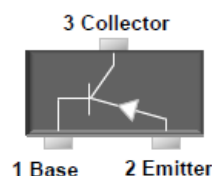

ABSOLUTE MAXIMUM RATINGS ( $T_A = 25^\circ\text{C}$ unless otherwise noted)					
PARAMETER	SYMBOL	BC807-16	BC807-25	BC807-40	UNIT
Marking code on the device		5A	5B	5C	
Power dissipation	$P_D$	0.3			W
Collector-base voltage, emitter open	$I_C = -10 \mu\text{A}, I_E = 0$	$V_{CBO}$	-50		V
Collector-emitter voltage, base open	$I_C = -10 \text{mA}, I_B = 0$	$V_{CEO}$	-45		V
Emitter-base voltage, collector open	$I_E = -1 \mu\text{A}, I_C = 0$	$V_{EBO}$	-5		V
Collector current, dc	$I_C$	-0.5			A
Junction temperature	$T_J$	-55 to +150			$^\circ\text{C}$
Storage temperature	$T_{STG}$	-55 to +150			$^\circ\text{C}$

<b>ELECTRICAL SPECIFICATIONS</b> ( $T_A = 25^\circ\text{C}$ unless otherwise noted)						
PARAMETER	CONDITIONS	SYMBOL	MIN	TYP	MAX	UNIT
Collector cutoff current, emitter open	$V_{CB} = -45\text{ V}, I_E = 0$	$I_{CBO}$	-	-	-0.1	$\mu\text{A}$
	$V_{CB} = -40\text{ V}, I_B = 0$		-	-	-0.2	
Emitter cutoff current, collector open	$V_{EB} = -4\text{ V}, I_C = 0$	$I_{EBO}$	-	-	-0.1	$\mu\text{A}$
DC current gain	$V_{CE} = -1\text{ V}, I_C = -100\text{ mA}$	BC807-16	100	-	250	
		BC807-25	160	-	400	
		BC807-40	250	-	600	
Collector-emitter saturation voltage	$I_C = -500\text{ mA}, I_B = -50\text{ mA}$	$V_{CE(sat)}$	-	-	-0.7	V
Base-emitter saturation voltage	$I_C = -500\text{ mA}, I_B = -50\text{ mA}$	$V_{BE(sat)}$	-	-	-1.2	V
Transition frequency	$V_{CE} = -5\text{ V}, I_C = -10\text{ mA}, f = 50\text{ MHz}$	$f_T$	100	-	-	MHz

<b>ORDERING INFORMATION</b>				
PART NO.	PACKING CODE	PACKING CODE SUFFIX(*)	PACKAGE	PACKING
BC807-XX (Note 1)	RF	G	SOT-23	3K / 7" Reel

**Notes:**

1. "xx" is Device Code is "16" and "25" and "40"

\*: optional available

<b>EXAMPLE</b>				
EXAMPLE P/N	PART NO.	PACKING CODE	PACKING CODE SUFFIX	DESCRIPTION
BC807-16 RFG	BC807-16	RF	G	Green compound

**CHARACTERISTICS CURVES**

( $T_A = 25^\circ\text{C}$  unless otherwise noted)

**Fig.1 Power Derating Curve**

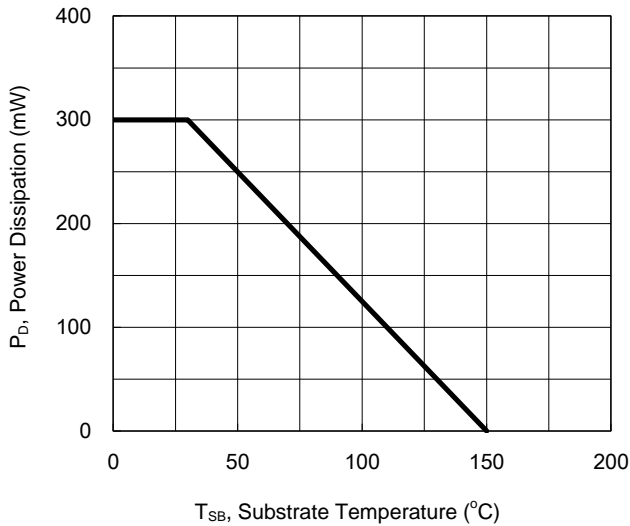

**Fig. 2 Gain Bandwidth Product VS. Collector Current**

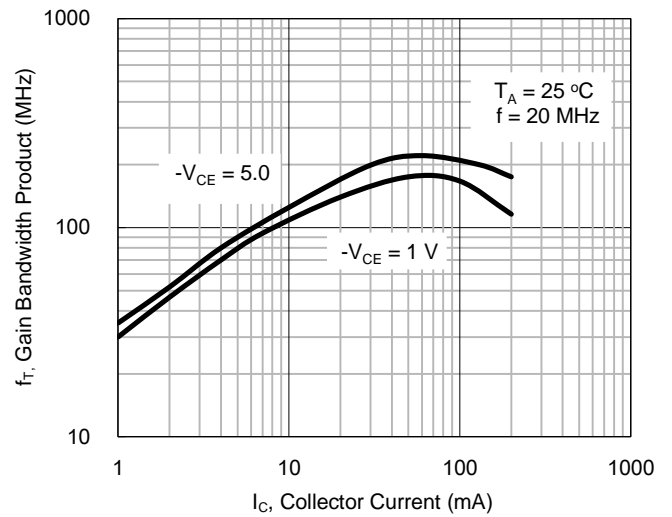

**Fig.3 Collector Sat Voltage VS. Collector Current**

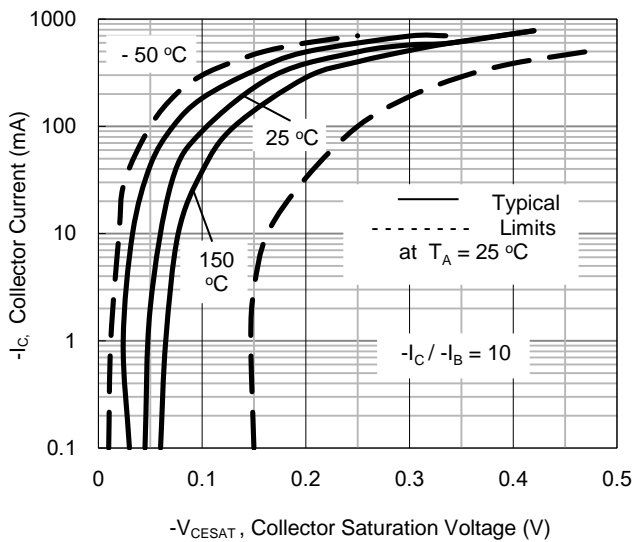

**Fig.4 DC Current Gain VS. Collector Current**

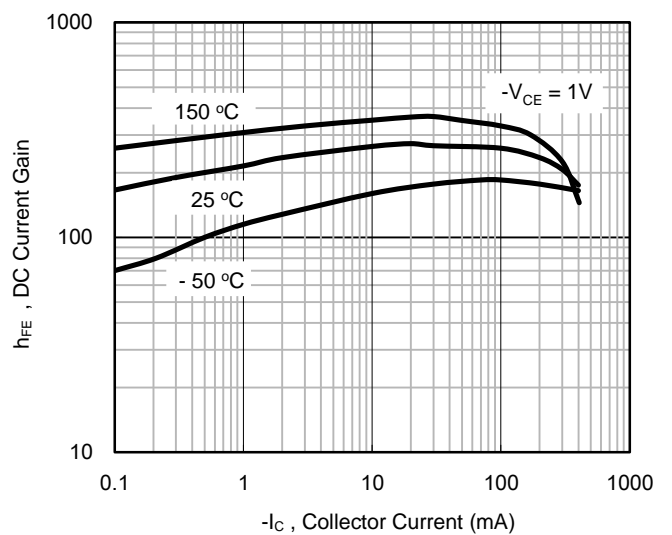

**CHARACTERISTICS CURVES**

( $T_A = 25^\circ\text{C}$  unless otherwise noted)

**Fig.5 Typical Emitter-Collector Characteristics**

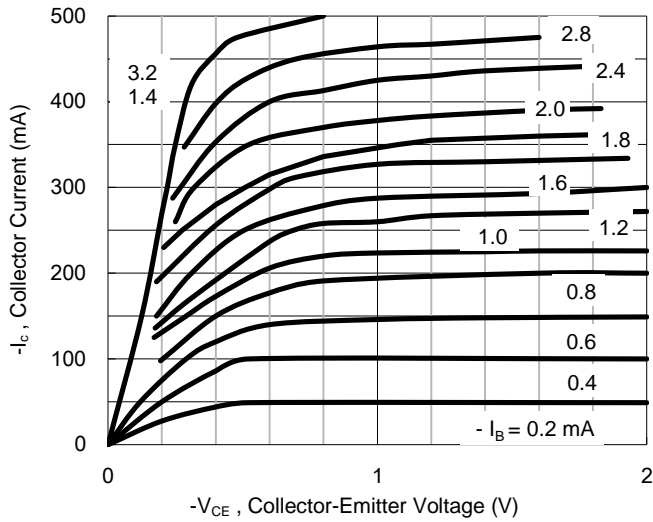

**Fig. 6 Typical Transient Thermal Characteristics**

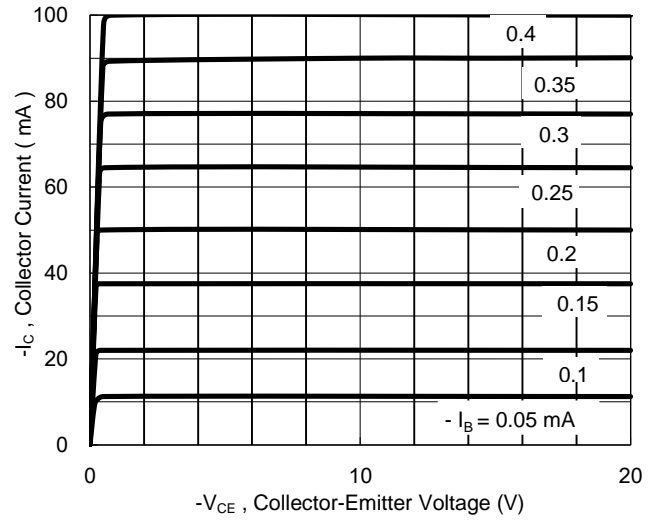

**PACKAGE OUTLINE DIMENSION**

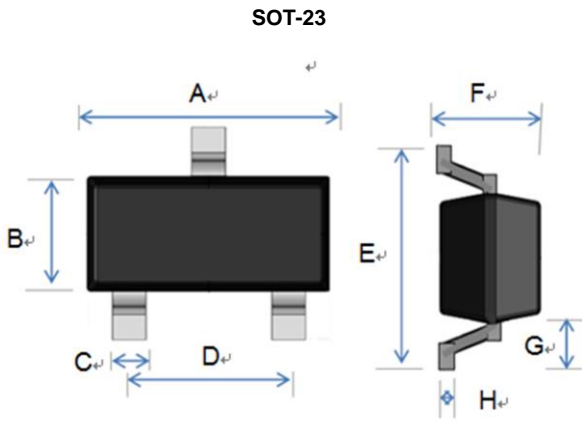

DIM.	Unit(mm)		Unit(inch)	
	Min	Max	Min	Max
A	2.70	3.10	0.106	0.122
B	1.10	1.50	0.043	0.059
C	0.30	0.51	0.012	0.020
D	1.78	2.04	0.070	0.080
E	2.10	2.64	0.083	0.104
F	0.89	1.30	0.035	0.051
G	0.55 REF		0.022 REF	
H	0.10 REF		0.004 REF	

**SUGGEST PAD LAYOUT**

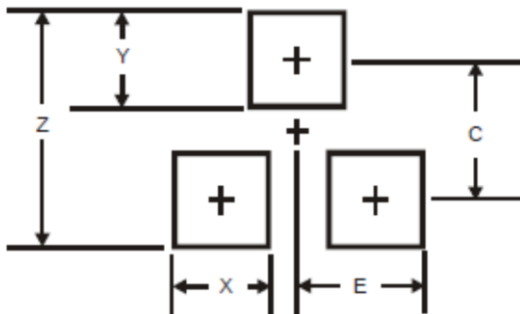

DIM.	Unit(mm)	Unit(inch)
	TYP	TYP
Z	2.8	0.11
X	0.7	0.03
Y	0.9	0.04
C	1.9	0.07
E	1.0	0.04

## Notice

Specifications of the products displayed herein are subject to change without notice. TSC or anyone on its behalf, assumes no responsibility or liability for any errors or inaccuracies.

Information contained herein is intended to provide a product description only. No license, express or implied, to any intellectual property rights is granted by this document. Except as provided in TSC's terms and conditions of sale for such products, TSC assumes no liability whatsoever, and disclaims any express or implied warranty, relating to sale and/or use of TSC products including liability or warranties relating to fitness for a particular purpose, merchantability, or infringement of any patent, copyright, or other intellectual property right.

The products shown herein are not designed for use in medical, life-saving, or life-sustaining applications. Customers using or selling these products for use in such applications do so at their own risk and agree to fully indemnify TSC for any damages resulting from such improper use or sale.