

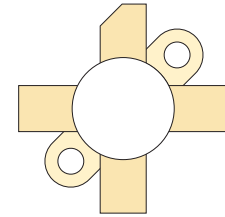

## RF POWER VERTICAL MOSFET

The VRF141 is a gold-metallized silicon n-channel RF power transistor designed for broadband commercial and military applications requiring high power and gain without compromising reliability, ruggedness, or inter-modulation distortion.



### FEATURES

- Improved Ruggedness  $V_{(BR)DSS} = 80\text{ V}$
- 150W with 22dB Typical Gain @ 30MHz, 28V
- 150W with 13dB Typical Gain @ 175MHz, 28V
- Excellent Stability & Low IMD
- Common Source Configuration
- Available in Matched Pairs
- 30:1 Load VSWR Capability at Specified Operating Conditions
- Nitride Passivated
- Refractory Gold Metallization
- High Voltage Replacement for MRF141
- RoHS Compliant 

### Maximum Ratings

All Ratings:  $T_c = 25^\circ\text{C}$  unless otherwise specified

Symbol	Parameter	VRF141(MP)	Unit
$V_{DSS}$	Drain-Source Voltage	80	V
$I_D$	Continuous Drain Current @ $T_c = 25^\circ\text{C}$	20	A
$V_{GS}$	Gate-Source Voltage	$\pm 40$	V
$P_D$	Total Device dissipation @ $T_c = 25^\circ\text{C}$	300	W
$T_{STG}$	Storage Temperature Range	-65 to 150	°C
$T_J$	Operating Junction Temperature	200	

### Static Electrical Characteristics

Symbol	Parameter	Min	Typ	Max	Unit
$V_{(BR)DSS}$	Drain-Source Breakdown Voltage ( $V_{GS} = 0\text{V}$ , $I_D = 100\text{mA}$ )	80			V
$V_{DS(ON)}$	On State Drain Voltage ( $I_{D(ON)} = 10\text{A}$ , $V_{GS} = 10\text{V}$ )		0.9	1.0	
$I_{DSS}$	Zero Gate Voltage Drain Current ( $V_{DS} = 60\text{V}$ , $V_{GS} = 0\text{V}$ )			1.0	mA
$I_{GSS}$	Gate-Source Leakage Current ( $V_{DS} = \pm 20\text{V}$ , $V_{GS} = 0\text{V}$ )			1.0	$\mu\text{A}$
$g_{fs}$	Forward Transconductance ( $V_{DS} = 10\text{V}$ , $I_D = 5\text{A}$ )	5.0			mhos
$V_{GS(TH)}$	Gate Threshold Voltage ( $V_{DS} = 10\text{V}$ , $I_D = 100\text{mA}$ )	2.9	3.6	4.4	V

### Thermal Characteristics

Symbol	Characteristic	Min	Typ	Max	Unit
$R_{\theta JC}$	Junction to Case Thermal Resistance			0.60	°C/W

### Dynamic Characteristics

Symbol	Parameter	Test Conditions	Min	Typ	Max	Unit
$C_{ISS}$	Input Capacitance	$V_{GS} = 0\text{V}$		400		pF
$C_{OSS}$	Output Capacitance	$V_{DS} = 28\text{V}$		375		
$C_{RSS}$	Reverse Transfer Capacitance	$f = 1\text{MHz}$		50		

 **CAUTION:** These Devices are Sensitive to Electrostatic Discharge. Proper Handling Procedures Should Be Followed.

## Functional Characteristics

VRF141(MP)

Symbol	Parameter	Min	Typ	Max	Unit
$G_{PS}$	$f_1 = 30\text{MHz}, f_2 = 30.001\text{MHz}, V_{DD} = 28\text{V}, I_{DQ} = 250\text{mA}, P_{out} = 150\text{W}_{PEP}$	16	20		dB
$G_{PS}$	$f_1 = 175\text{MHz}, V_{DD} = 28\text{V}, I_{DQ} = 250\text{mA}, P_{out} = 150\text{W}$		13		
$\eta$	$f_1 = 30\text{MHz}, f_2 = 30.001\text{MHz}, V_{DD} = 28\text{V}, I_{DQ} = 250\text{mA}, P_{out} = 150\text{W}_{PEP}$	40	45		%
$IMD_{(d3)}$	$f_1 = 30\text{MHz}, f_2 = 30.001\text{MHz}, V_{DD} = 28\text{V}, I_{DQ} = 250\text{mA}, P_{out} = 150\text{W}_{PEP}$ <sup>1</sup>		-30	-28	dB
$IMD_{(d11)}$	$f_1 = 30\text{MHz}, f_2 = 30.001\text{MHz}, V_{DD} = 28\text{V}, I_{DQ} = 250\text{mA}, P_{out} = 150\text{W}_{PEP}$		-60		
$\psi$	$f_1 = 30\text{MHz}, f_2 = 30.001\text{MHz}, V_{DD} = 28\text{V}, I_{DQ} = 250\text{mA}, P_{out} = 150\text{W}_{PEP}$ 30:1 VSWR - All Phase Angles	No Degradation in Output Power			

## Class A Characteristics

Symbol	Test Conditions	Min	Typ	Max	Unit
$G_{PS}$	$f_1 = 30\text{MHz}, f_2 = 30.001\text{MHz}, V_{DD} = 28\text{V}, I_{DQ} = 4.0\text{A}, P_{out} = 50\text{W}_{PEP}$		23		dB
$IMD_{(d3)}$	$f_1 = 30\text{MHz}, f_2 = 30.001\text{MHz}, V_{DD} = 28\text{V}, I_{DQ} = 4.0\text{A}, P_{out} = 50\text{W}_{PEP}$		-50		
$IMD_{(d9-d13)}$	$f_1 = 30\text{MHz}, f_2 = 30.001\text{MHz}, V_{DD} = 28\text{V}, I_{DQ} = 4.0\text{A}, P_{out} = 50\text{W}_{PEP}$		-75		

1. To MIL-STD-1311 Version A, test method 2204B, Two Tone, Reference Each Tone

Microsemi reserves the right to change, without notice, the specifications and information contained herein.

## Typical Performance Curves

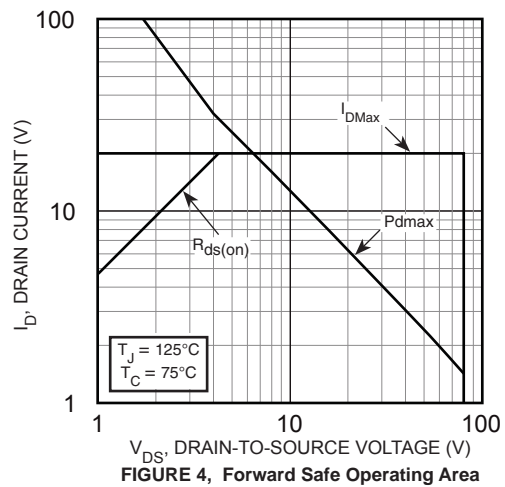
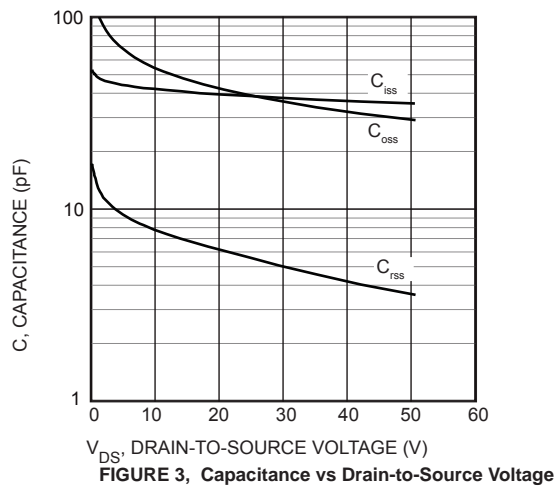
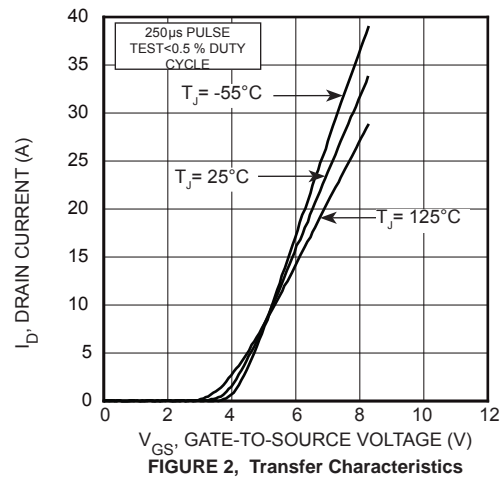
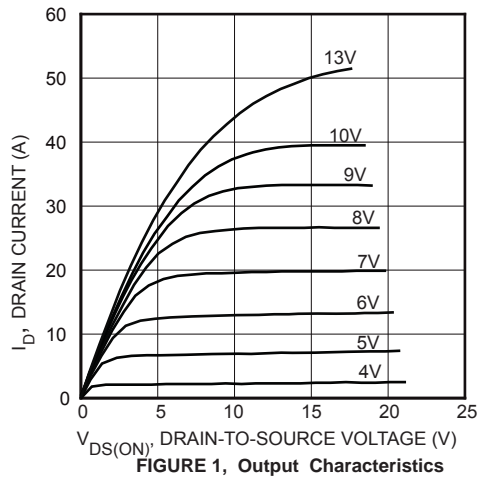

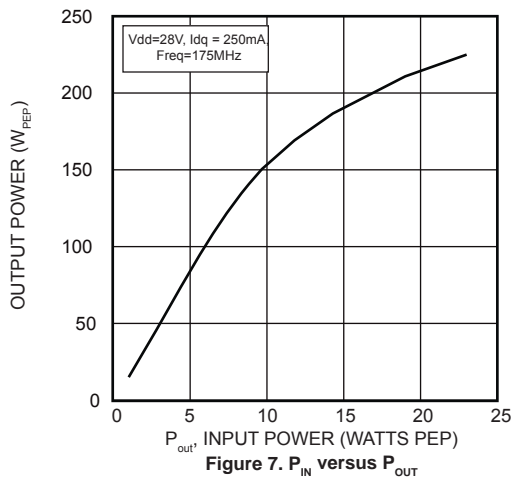
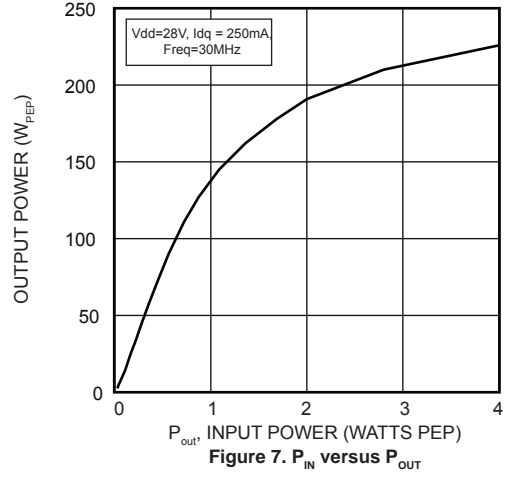
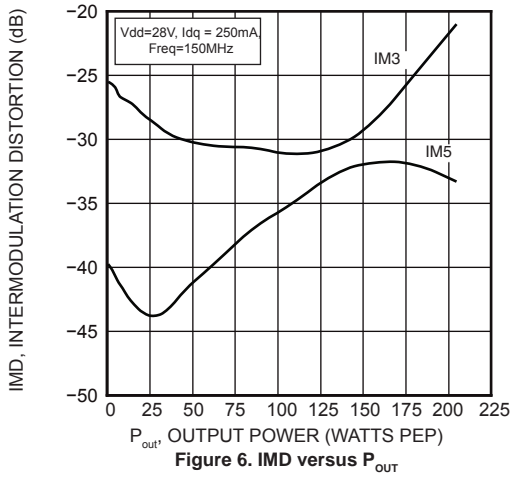
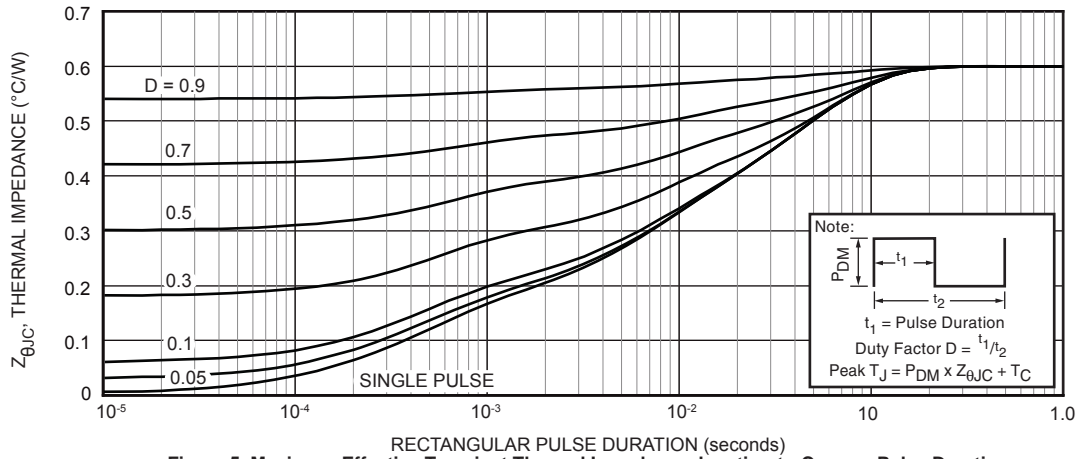

## 30 MHz test Circuit

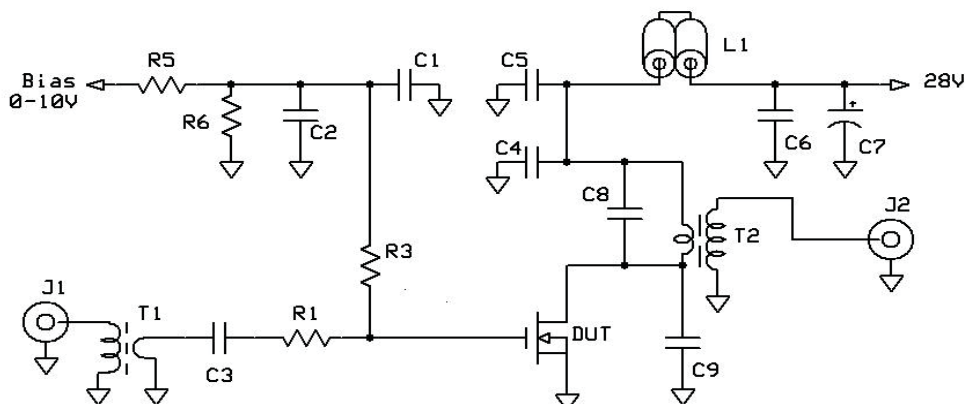

- |   |                               |
|---|-------------------------------|
| C1 - 1uF 50V tantalum                           | C9 - 100 pF ATC 100B          |
| C2-C6 - 0.1uF 100V SMT                          | L1 - two ferrite beads on #18 |
| C7 - 15uF 100V Elect                            | R1 - 1 ohm 1 W SMT            |
| C8 - 820 pF ATC 100B                            | R3 - 200 ohm 1/2 Carbn        |
| T1 - 16:1 bead/tube transformer                 | R4 - 470 ohm 1W               |
| T2 = 1:25 broadband bead/tube transformer u=125 | R5 R6 - 2200 ohm 1/4W         |

## 175 MHz test Circuit

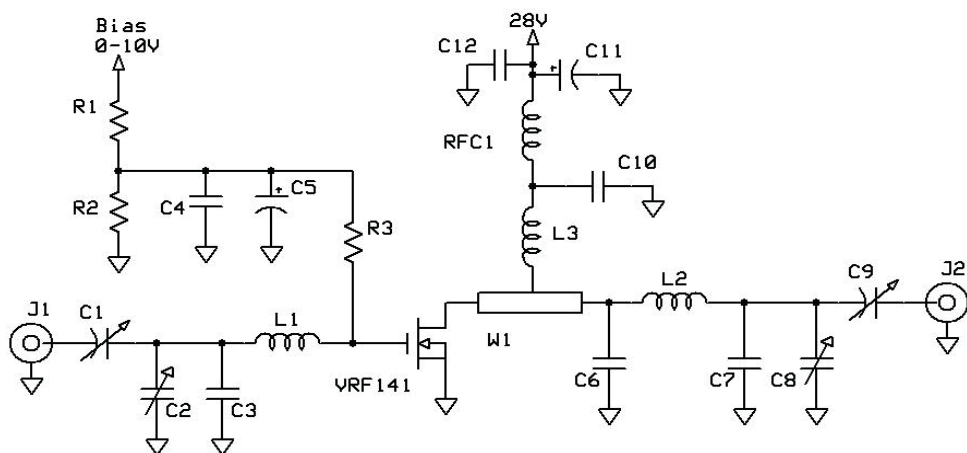

- |                             |  |
|-----------------------------|--|
| C1, 2, 8, 9 - ARCO 463      | L1 - 3/4" #18 ga into Hairpin              |
| C3 C7 - 25 pF ATC 100B      | W1 - printed line 0.23"W x 0.7" L          |
| C4 C10 C12 - 0.1uF 100V SMT | L2 - 2t #16 ga .25" dia x .25" ~ 35nH      |
| C5 - 1 uF 15WV tant         | L3 - 2 turns #16 ga 5/16" ID tight. ~ 50nH |
| C6 - 270 pF ATC 100B        | R1 R2 - 2.2k ohm 1/4W                      |
| C10 - .05 100V 1206 SMT     | R3 - 150 ohm 1/4W                          |
| C11 - 15uF 100V Elect       | RFC1 Fair-Rite 2961666631 (VK200-4B)       |

Adding MP at the end of P/N specifies a matched pair where  $V_{GS(TH)}$  is matched between the two parts.  $V_{TH}$  values are marked on the devices per the following table.

Code	Vth Range	Code 2	Vth Range
A	2.900 - 2.975	M	3.650 - 3.725
B	2.975 - 3.050	N	3.725 - 3.800
C	3.050 - 3.125	P	3.800 - 3.875
D	3.125 - 3.200	R	3.875 - 3.950
E	3.200 - 3.275	S	3.950 - 4.025
F	3.275 - 3.350	T	4.025 - 4.100
G	3.350 - 3.425	W	4.100 - 4.175
H	3.425 - 3.500	X	4.175 - 4.250
J	3.500 - 3.575	Y	4.250 - 4.325
K	3.575 - 3.650	Z	4.325 - 4.400

$V_{TH}$  values are based on Microsemi measurements at datasheet conditions with an accuracy of 1.0%.

**M174 Package Outline .5" SOE**  
**All Dimensions to be ±.005"**

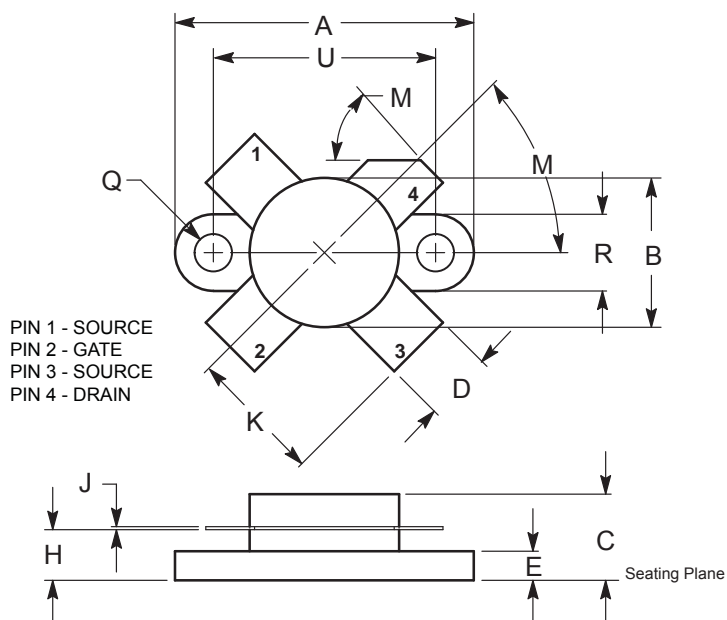

DIM	INCHES		MILLIMETERS	
	MIN	MAX	MIN	MAX
A	0.096	0.990	24.39	25.14
B	0.465	0.510	11.82	12.95
C	0.229	0.275	5.82	6.98
D	0.216	0.235	5.49	5.96
E	0.084	0.110	2.14	2.79
H	0.144	0.178	3.66	4.52
J	0.003	0.007	0.08	0.17
K	0.435		11.0	
M	45° NOM		45° NOM	
Q	0.115	0.130	2.93	3.30
R	0.246	0.255	6.25	6.47
U	0.720	0.730	18.29	18.54