

LCFEA Series

RoHS



Pinout

Two Lines

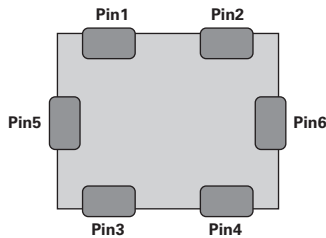

Item	Description	Source	Equipment
R _{dc}	Pin 1-4, 2-3	10mA DC Source	Source Meter
CM Impedance	Pin 1-2(Short) to Pin 3-4(Short)	500mV	LCR Meter (3GHz)
IL	Pin 5 or 6 to Pin 1,2,3,4	5V DC Source	Source Meter
IR _{CR}	Pin 1-2 or Pin 3-4	5V DC Source	Source Meter

Four Lines

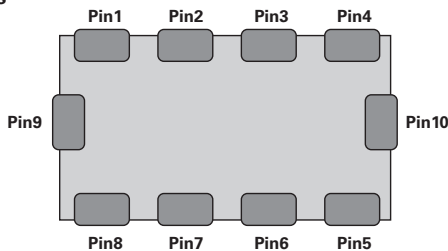

Item	Description	Source	Equipment
R _{dc}	Pin 1-8, 2-7, 3-6, 4-5	10mA DC Source	Source Meter
CM Impedance	Pin 1-2(Short) to Pin 8-7(Short) Pin 3-4(Short) to Pin 6-5(Short)	500mV	LCR Meter (3GHz)
IL	Pin 9 or 10 to Pin 1~4 or 5~8	5V DC Source	Source Meter

Description

This specification covers the engineering requirements for both Common Mode Noise Filter (CMF) and ESD Protection especially for high speed differential serial interfaces, such as USB 3.1 , USB 2.0 , MIPI D-PHY or HDMI, and RGB line, LVDS line.

AEC-Q200 qualified common mode noise filter will help to choke and attenuate the noise for the growing number of electronic applications in modern vehicles.

Features

- AEC-Q200 qualified
- Effective for suppressing common mode noise and almost no effect for high speed differential data line
- Differential mode cut-off frequency up to 4.5GHz at -3dB
- Common mode filters and ESD suppression devices integrated
- Low profile package
- Ceramic multilayer type SMD component
- Non-polarized product
- Conforming to RoHS directive.
- ±15kV air, ±8kV contact ESD protection (IEC 61000-4-2 Level 4)
- High temperature soldering guaranteed: 260°C/10 seconds

Applications

- *Automotive*
 - Infotainment: Display, Car Navigation, Head Unit, USB Jack
 - ADAS: Car Camera System
 - Telematics Control Unit, E-Call system, Smart Keyless Entry system
 - RGB line, LVDS line, HDMI for AVN, High-speed CAN BUS line
- *Consumer*
 - PDP, LCD TV, DVD Player, PC, Audio player, DSC, Set top box, Laptop, SSD, Home Automation
- *Portable/Wearable Devices*
 - Mobile phone, Tablet, Game console, POS, VR, Dongle

Functional Block Diagram

LCFEA121002A900TG, LCFEA201202A900TG

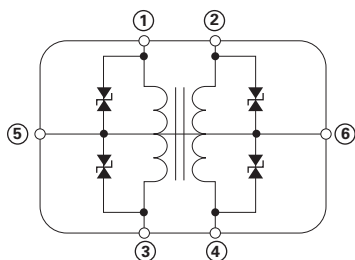

①~④: Data Line; ⑤, ⑥: Ground

LCFEA201204A101TG

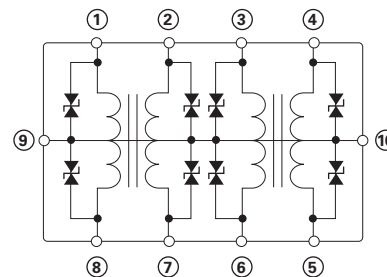

①~⑧: Data Line; ⑨, ⑩: Ground

Electrical Characteristics

Part Number	Size (mm)	Size (inch)	Common Mode Impedance (Ω)	Rated Current (mA) Max.	Cut-off Freq/GHz	DC Resistance (Ω) Max.	Number of Lines	Leakage Current (μ A) Max.	Insulation Resistance (M Ω) Min.	Rated Voltage (V)
LCFEA121002A900TG	1210	0504	90(\pm 25%)	100	4.65	4.0	2	1.0	10	5
LCFEA201202A900TG	1212	0805	90(\pm 25%)	150	4.65	4.0	2	1.0	10	5
LCFEA201204A101TG	2012	0805	90(\pm 25%)	100	3.38	4.0	4	1.0	10	5

Test Conditions

- Common Mode Impedance (Ω): @100MHz
- DC Resistance (Ω): 25°C \pm 2°C
- Leakage Current (μ A): 5V
- Capacitance (pF): 0.5Vrms @1MHz
- Insulation Resistance (Max. M Ω): 5V
- Rated Voltage(V): 25°C \pm 2°C
- Rated Current (mA): 25°C \pm 2°C

Impedance Curves
Common Mode

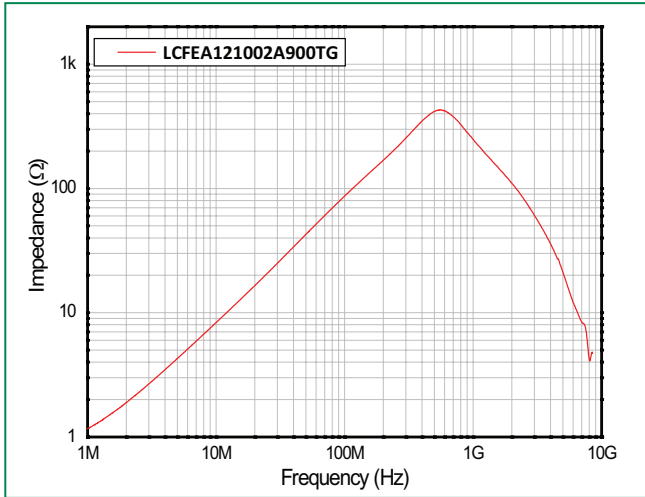

Differential Mode

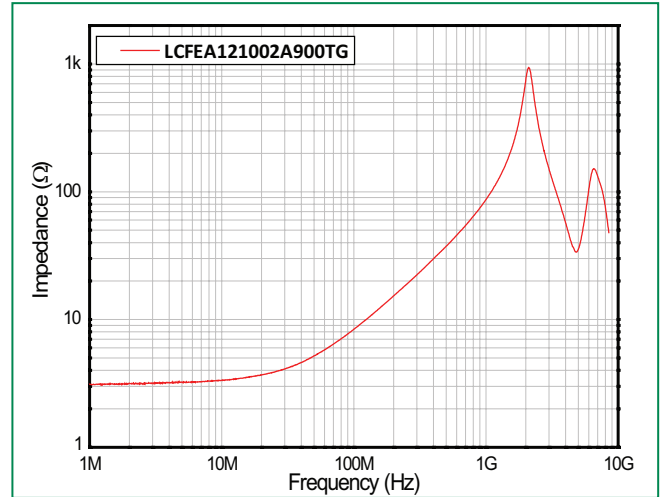

Transmission Characteristics (S-parameter)
Common Mode S21

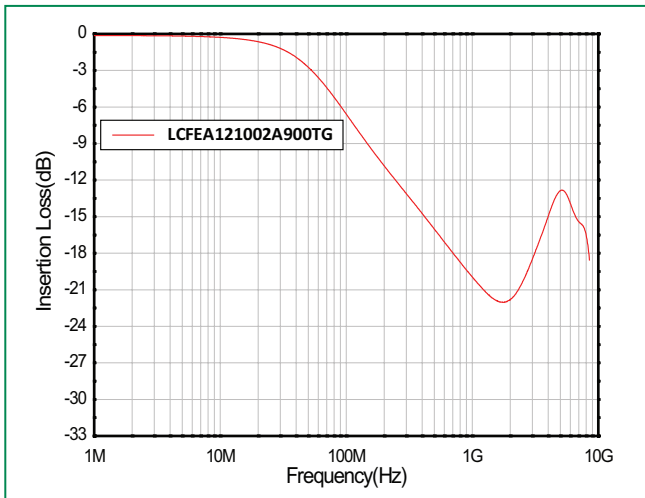

Differential Mode S21

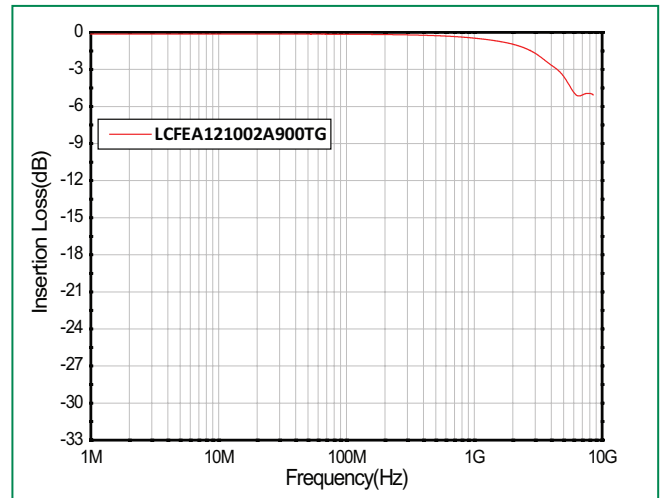

**Impedance Curves
Common Mode**

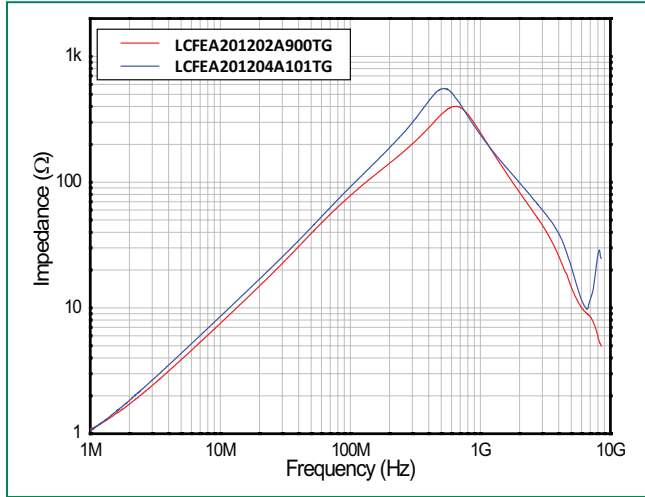

Differential Mode

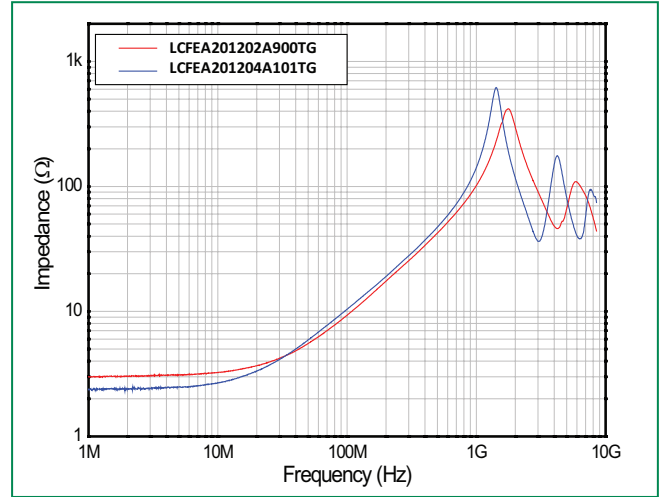

**Transmission Characteristics (S-parameter)
Common Mode S21**

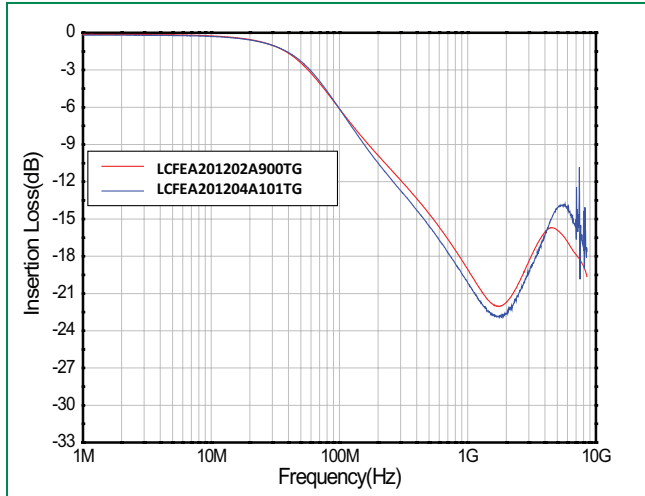

Differential Mode S21

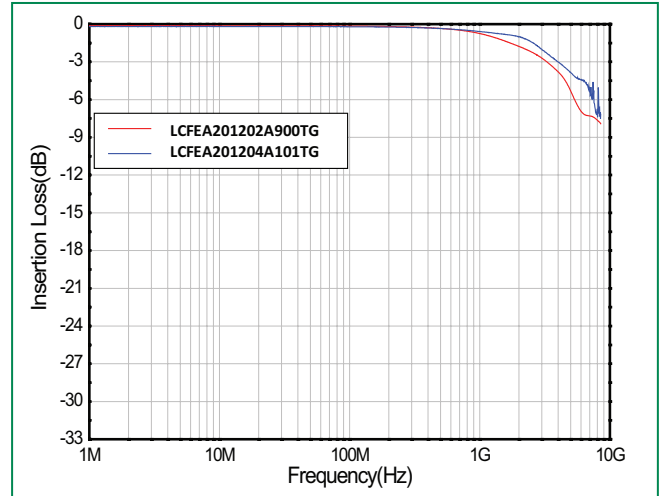

Soldering Parameters

Reflow Condition		Pb-free assembly
Pre Heat	- Temperature Min ($T_{s(min)}$)	160°C
	- Temperature Max ($T_{s(max)}$)	185°C
	- Time (Min to Max) (t_s)	100 – 120 seconds
Average Ramp-up Rate (Liquidus Temp (T_L) to peak)		1°C/second max
$T_{s(max)}$ to T_L - Ramp-up Rate		1°C/second max
Reflow	- Temperature (T_L) (Liquidus)	220°C
	- Temperature (t_L)	30 – 50 seconds
Peak Temperature (T_P)		260°C
Time within 5°C of actual peak Temperature (t_p)		5~10 seconds
Ramp-down Rate		2°C/second max
Time 25°C to Peak Temperature (T_P)		4 minutes max
Do not exceed		260°C
Wave Soldering		260°C, 10 sec. max

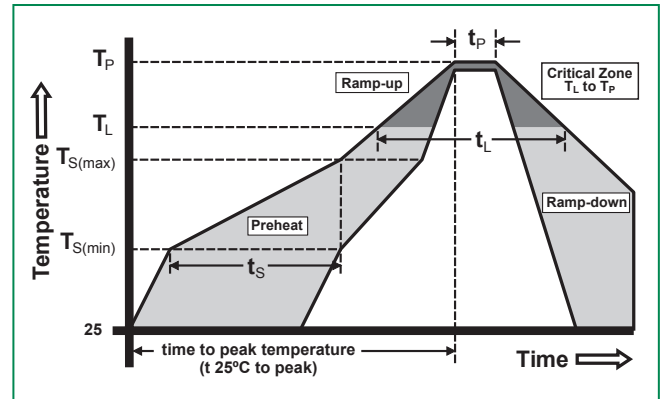

Recommended Soldering Profile (Lead free condition)

Product Characteristics

Lead Pull Strength	5N
Solderability	260°C, ≤10s (Reflow), Max 380°C, ≤5s (Soldering iron)
Soldering Heat Resistance	Max 260°C 10sec (Wave), Max Temperature: Max 380°C (Max 5sec)
Operating Temperature	-40°C ~ + 125°C
Climatic Category	-40°C ~ + 85°C/8 days
Stock Conditions	-10°C ~ + 40°C RH, ≤ 70%
Vibration Resistance	5 g's for 20 minutes, 12 cycles each of 3 orientations

Dimensions

Unit = mm

LCFEA121002A900TG

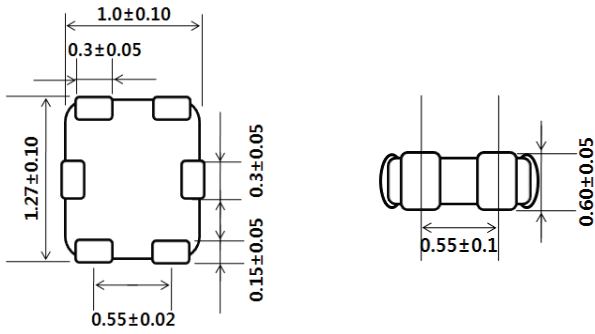

Recommended Footprint and Stencil Mask

Unit = mm

Stencil Mask T = 0.10mm

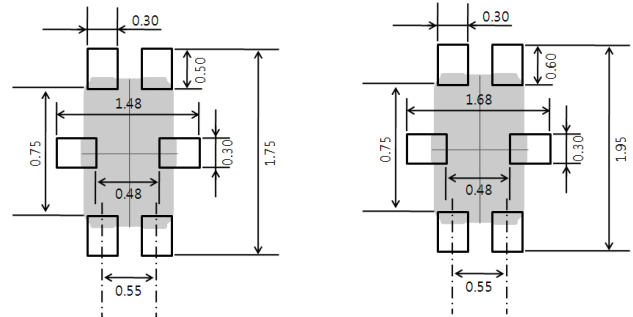

LCFEA201202A900TG

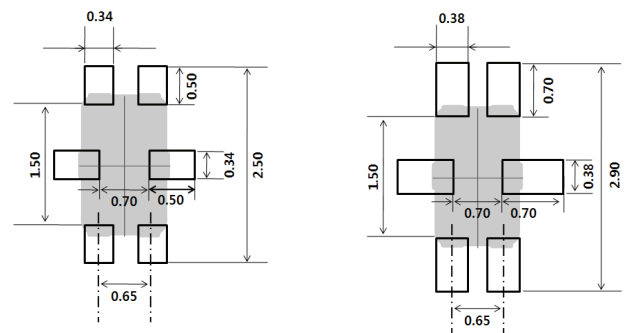
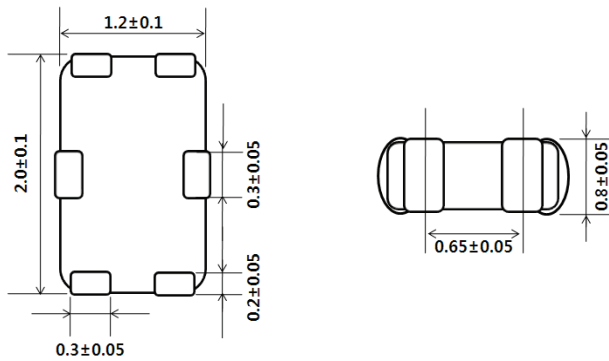

LCFEA201204A101TG

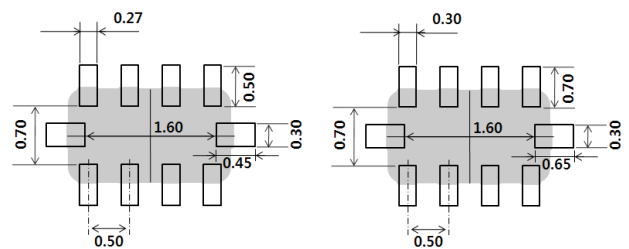
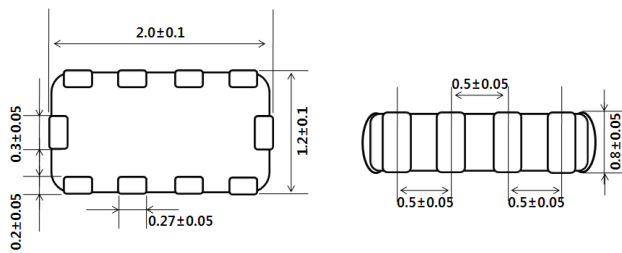

Carrie Tape Dimensions

LCFEA121002A900TG

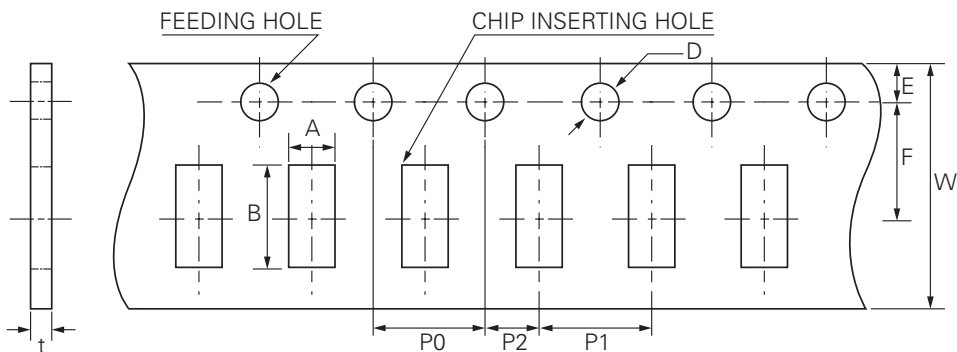

Symbol	Dimensions
	Millimeters
A	1.15±0.05
B	1.50±0.05
W	8.0+0.30, .0.10
F	3.50±0.05
E	1.75±0.05
P1	4.00±0.10
P2	2.00±0.05
P0	4.00±0.10
D	1.55±0.03
T	0.75±0.05

LCFEA201202A900TG, LCFEA201204A101TG

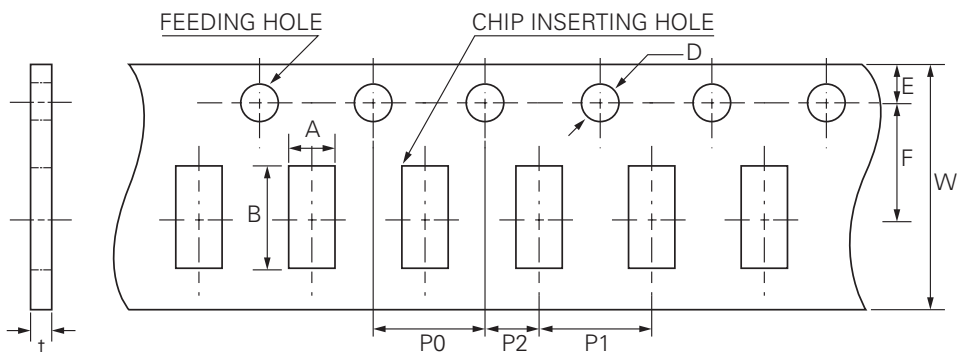

Symbol	Dimensions
	Millimeters
A	1.55±0.05
B	2.30±0.05
W	8.00±0.10
F	3.50±0.05
E	1.75±0.05
P1	4.00±0.10
P2	2.00±0.05
P0	4.00±0.10
D	1.55±0.03
T	0.95±0.05

Tape and Reel Dimension

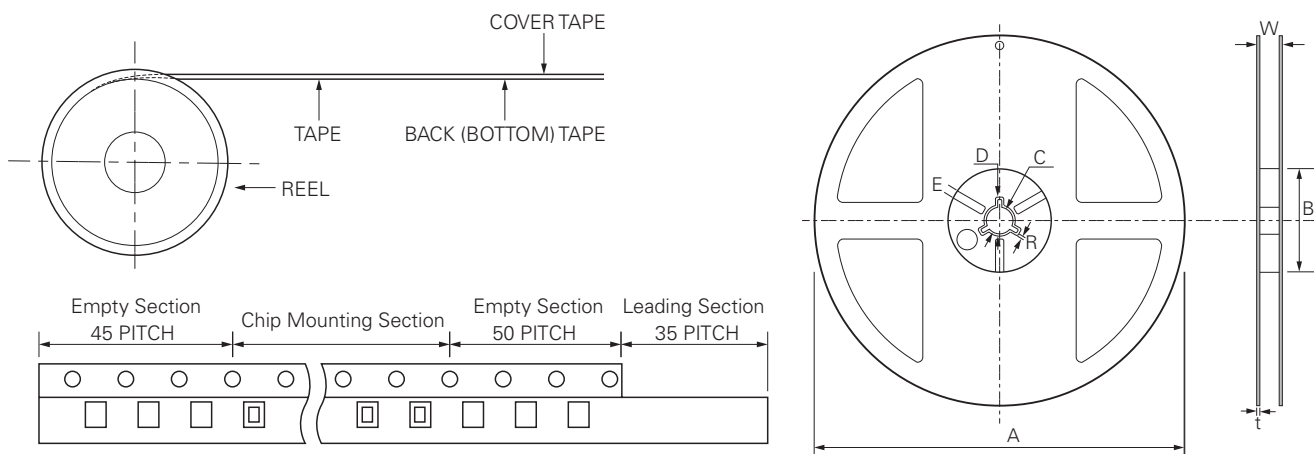

(1) Reel Materials: Polystyrene (2) Label (3) Taping
- Standard Packing Quantity per Reel (Ø178)
- PE Tape: 4,000pcs

Code	A	B	C	D	E	W	T	R
Dimension	Ø178±2	Min. Ø50	Ø13±0.5	Ø20±0.8	3.0±0.5	10±1.5	1.3±0.2	1.0±0.2

Part Numbering System

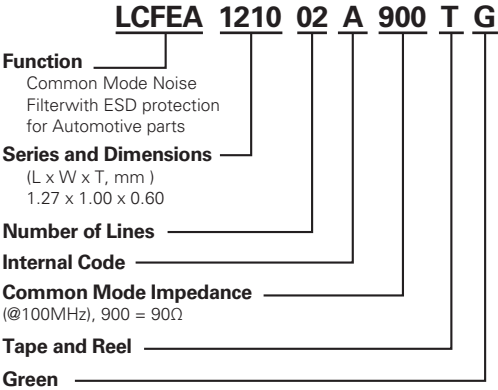

Ordering Information

Part Number	Reel Quantity
	4,000